



ON Semiconductor

Universal AC Input, 5 V or 12 V Output, 20 Watt Power Supply

Device	Application	Input Voltage	Output Power	Topology	I/O Isolation
NCP1129 NCP431	Smart Meters, Electric Meters, White Goods	85 to 265 Vac	20 W Nominal 25 W Peak	CCM Flyback	Isolated (3 kV)

	Output Specification	Output Specification
Output Voltage	5 Vdc	12 Vdc
Ripple	100 mV p/p @ full load	100 mV p/p @ full load
Nominal Current	4 Amps continuous	1.6 Amps continuous
Max Current	5 A maximum (with R7/8 modification)	2 A maximum (with R7/8 modification)
Min Current	zero	zero

PFC (Yes/No)	No, (Pout < 25 watts)
Efficiency	>80% from Half to Full Load
Input Protection	Fuse
Operating Temp. Range	0 to +50°C
Cooling Method	Convection
Standby Power	28 mW at 120 Vac 57 mW at 230 Vac

Circuit Description

This design note describes a simple 20 watt, universal AC input, constant voltage power supply intended for AC adapters, industrial equipment, or white goods where isolation from the AC mains is required, and low cost, high efficiency, and low standby power are essential.

The featured power supply is a simple CCM flyback topology utilizing ON Semiconductor's new NCP1129 monolithic switcher with integral 2 ohm, vertical channel MOSFET in a DIP8 package (U1). This Design Note provides the complete circuit schematic details and BOM for 5 volt, 4 amp power supply with a surge rating to 5 amps. Other output voltages from 3.3 Vdc up to 28 Vdc are easy to implement by modifying the values (or ratings) of a few of the secondary side output components and the flyback transformer's secondary winding (T1). The simple input EMI filter (C1, L1) is adequate to pass Level B for FCC conducted EMI compliance. The NCP431 programmable zener

is used as an error amplifier (U3), plus an optocoupler feedback scheme (U2) provides for excellent line and load regulation with high input-to-output safety isolation.

Performance characteristics for efficiency, output ripple, and internal MOSFET drain switching characteristics (Vds, Id) are shown in the figures and plots below for the 5V/4A version. Enhanced input transient protection (lightning, etc.) can be accomplished with the addition of an appropriate TVS device across the input of the diode bridge BD1.

Key Features

- Universal AC input range (85 – 265 Vac).
- Input filter for conducted EMI attenuation.
- Very low standby (no load) power consumption.
- Frequency foldback under light load and/or overcurrent conditions.
- Pi-network output ripple filter.
- Inherent over-current, over-voltage and over temperature protection.

DN05043/D

For applications requiring 10 to 15 watts output, the NCP1126 version of the controller can be used which has exactly the same circuitry as the NCP1129, but with a different MOSFET. For optimum thermal characteristics, the printed circuit board should be laid out to include clad "pours" around pins 5 and 6 of the DIP8 package (MOSFET drain pins). Resistors 9A & B (paralleled) set the peak current limit point for the internal overcurrent protection circuit of U1 and can be adjusted for desired max output current (see NCP112x data sheet). For output voltages other than 5 volts, typical circuit changes include the transformer turns ratio for both the secondary and the primary aux winding (12V transformer design included below), the value of R17 in the output voltage sense divider, and selecting appropriate voltage ratings for output rectifier D8 and output capacitors C9A, B & C. Depending on the transformer aux winding characteristics, it may be necessary to change R11 to a higher value resistance value to adjust the nominal Vcc voltage. Z1 can be added as an option in the event that the compliance range of the Vcc over the output load range exceeds the OVP trip point on pin 1 of U1 (28 volts). Such a scenario would be the result of a transformer with high leakage inductance.

Circuit Schematic

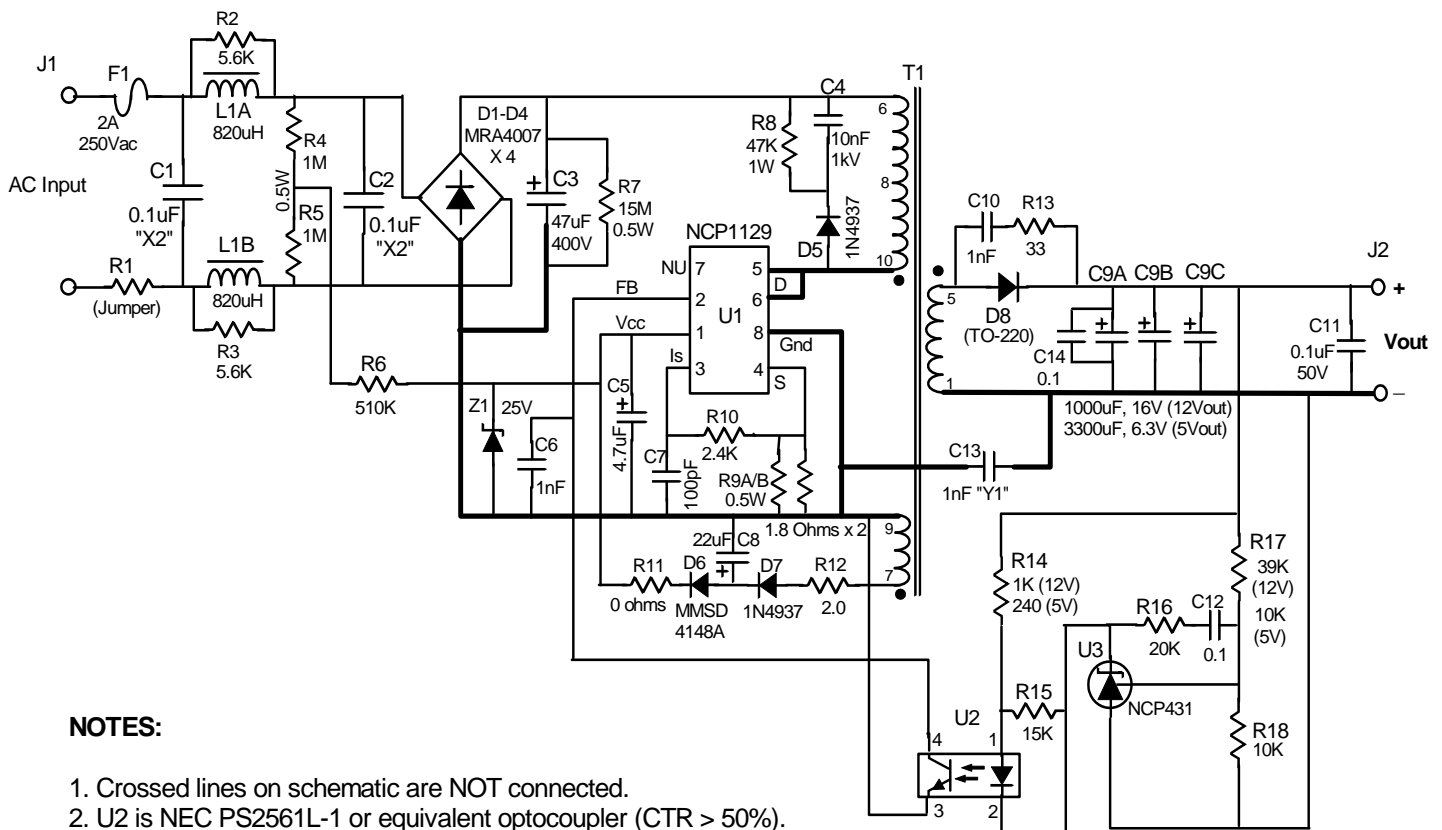

NOTES:

1. Crossed lines on schematic are NOT connected.
2. U2 is NEC PS2561L-1 or equivalent optocoupler (CTR > 50%).
3. R1 is optional for increased inrush limiting - use wire wound only.
4. L1A/L1B are Wurth # 7447728215 inductors (820 uH, 500mA).
5. Output caps (C9A/B/C) are radial lead, low impedance types (UCC LXV series or similar).
6. R11 is for Vcc trimming (< 28Vmax), typically zero ohms.
7. R9A/B sets max output current.
8. Heavy schematic lines indicate recommended ground plane areas.

**15/20 Watt NCP1126/1129 Power Supply
with Universal AC Input (Rev 3)**

DN05043/D

T1 Transformer Designs (Available from ICE Components Inc. and Würth Electronics)

5V/4A, 65 kHz Version (ICE # TO0915-1, Würth Electronics #750313860 Rev 01)

Core: E25/10/6 (812E250)

Primary A: 55 turns of 0.25mm mag wire

5V Secondary: 11 turns bifilar of 0.6mm Triple Insulated Wire (2 layers)

Aux/Vcc: 25 turns of 0.15mm mag wire spiral wound over 1 layer

Primary B: 55 turns of 0.25mm mag wire

Primary Inductance (Pri A and B in series): 2 mH +/- 10% (gap in center leg)

Leakage Inductance (5Vsec & Aux shorted): 40 uH max

12V/1.75A, 65 kHz Version (ICE # TO12157, Würth Electronics #750313861 Rev 01))

Core: E25/10/6 (812E250)

Primary A: 55 turns of 0.25mm mag wire

12V Secondary: 22 turns of 0.6mm Triple Insulated Wire (11 TPL, 2 layers)

Aux/Vcc: 22 turns of 0.15mm mag wire spiral wound over 1 layer

Primary B: 55 turns of 0.25mm mag wire

Primary Inductance (Pri A and B in series): 2 mH +/- 10% (gap in center leg)

Leakage Inductance (12Vsec & Aux shorted): 30 uH max

5 Volt & 12 Volt Efficiency vs Output Load Curves

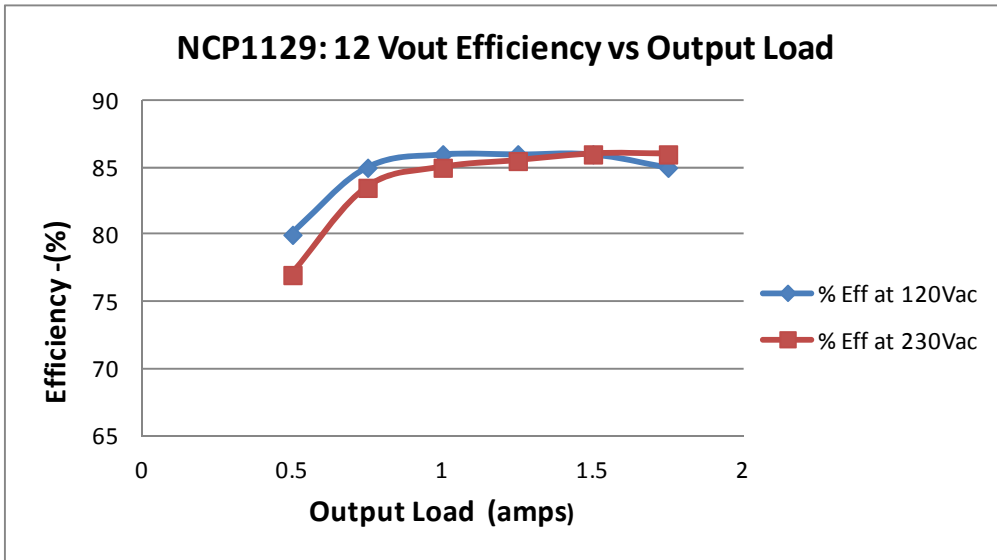
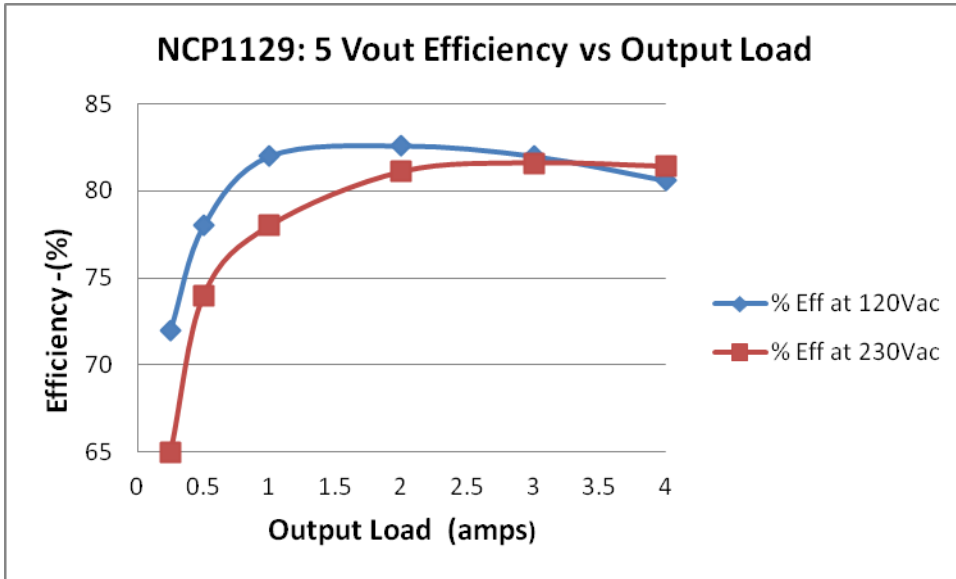

Full Load Output Ripple @ 120 Vac Input

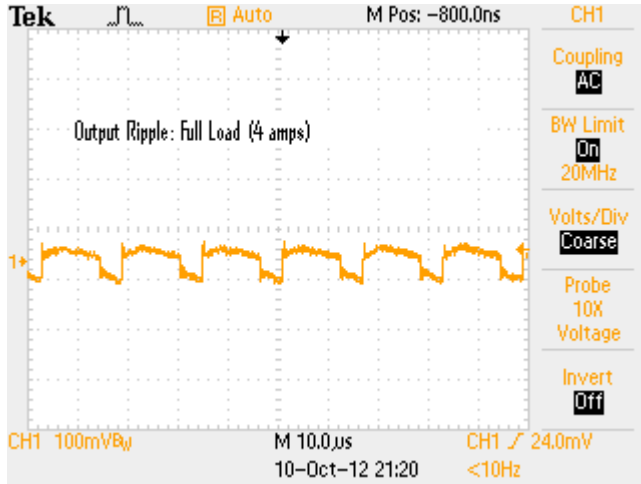

MOSFET Drain Voltage (120 Vac Input)

Full Load

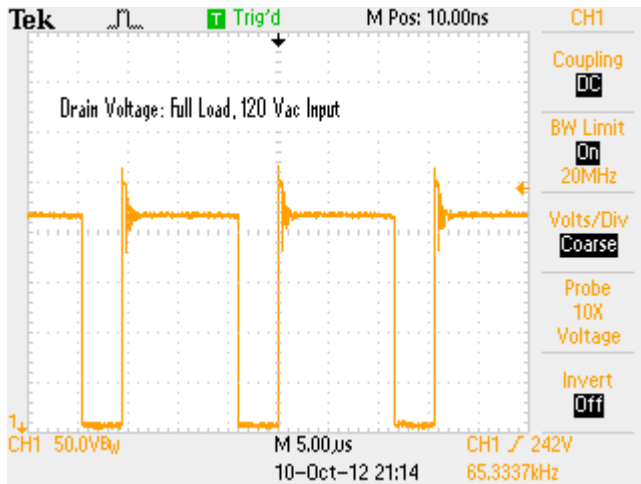

0.5 Amp Load

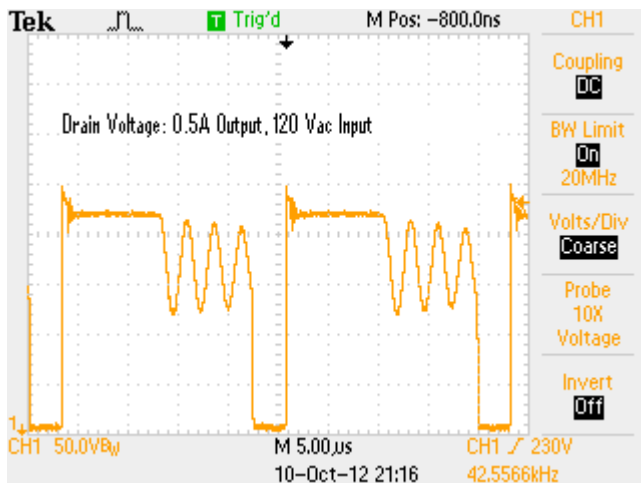

Mosfet Drain Current (120 Vac Input)

Full Load

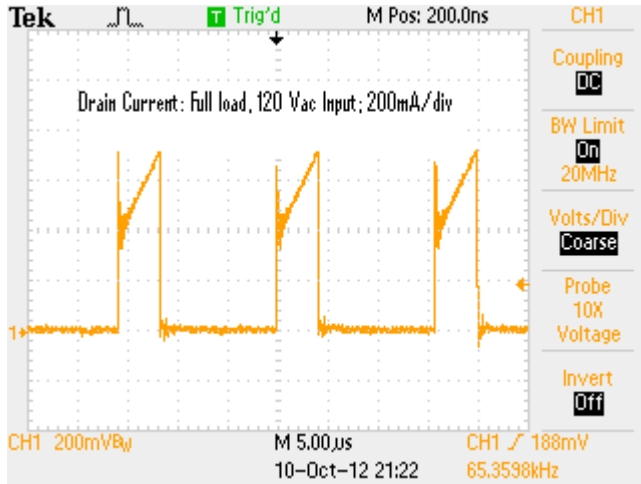

0.5 Amp Load

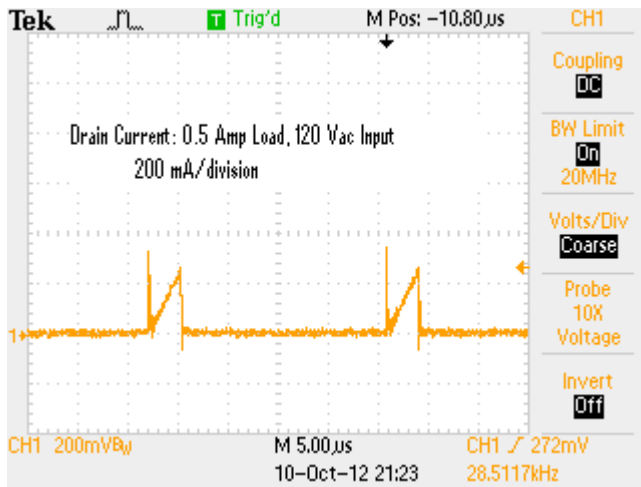

Conducted EMI Plot (5V/3.5A output; 120Vac input)

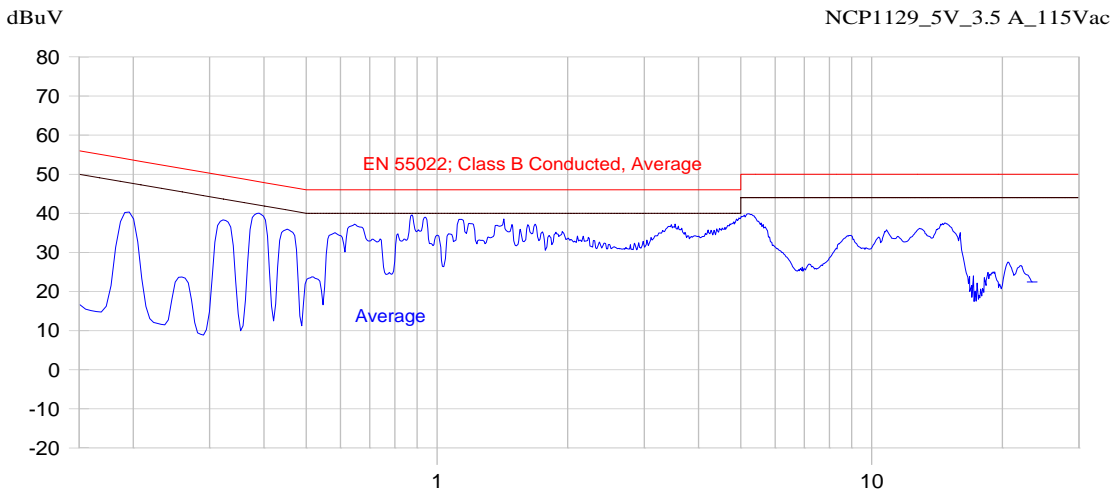

12/12/2012 1:29:02 PM

(Start = 0.15, Stop = 30.00) MHz

DN05043/D BOM

Bill of Materials for 20W NCP1126/1129 Flyback (Rev7A)

ON Semiconductor



2/7/2013

Designator	Qty	Description	Value	Tolerance	Footprint	Manufacturer	Manufacturer Part Number	Substitution Allowed	Lead Free	Comments
D8	1	Schottky diode	20A, 100V		TO-220	ON Semi	NTST20100CTG	No		
D1, 2, 3, 4	4	Diode - 60 Hz,	1A, 800V		SMA	ON Semi	MRA4007	No		
D5, D7	2	Diode - fast recov	1A, 600V		axial lead	ON Semi	1N4937	No		
D6	1	Signal diode	100mA, 100V		SOD-123	ON Semi	MMSD4148A	No		
Z1 (Optional)	1	Zener diode	25V		SOD-123	ON Semi	MMSZ5253B			
U3	1	Programmable zener	2.5V		SOT23	ON Semi	NCP431A	No		
U2	1	Optocoupler	CTR >= 0.5		4-pin SMD	Vishay or NEC	SFH6156A-4 or PS2561L-1	Yes		
U1	1	Controller - NCP1126/1129	65 kHz		DIP8	ON Semi	NCP1126/1129BP65G	No		
C1, C2	2	"X" cap, box type	100nF, X2		LS = 15 mm	Rifa, Wima	TBD	Yes		
C13	1	"Y1" cap, disc type	1nF, Y1		LS = 7.5 mm	Rifa, Wima	TBD	Yes		
C4	1	Ceramic cap, box	10 nF, 1kV	10%	13x4 mm, LS=10 mm	Vishay	MKT1822310635	Yes		
C6	1	Ceramic cap, monolythic	1 nF, 50V	10%	1206	AVX, Murata	TBD	Yes		
C11, 12, 14	3	Ceramic cap, monolythic	100nF, 50V	10%	1206	AVX, Murata	TBD	Yes		
C7	1	Ceramic cap, monolythic	100pF, 50V	10%	1206	AVX, Murata	TBD	Yes		
C10	1	Ceramic cap, monolythic	1 nF, 200V	10%	1206	AVX, Murata	TBD	Yes		
C3	1	Electrolytic cap	47uF, 400V	10%	LS=7.5mm, D=18mm	UCC	EKXG401ELL470MM20S	Yes		
C5	1	Electrolytic cap	4.7uF, 50Vdc	10%	LS=2.5mm, D=5mm	UCC, Panasonic	TBD	Yes		
C8	1	Electrolytic cap	22uF, 50Vdc	10%	LS=2.5mm, D=6.3mm	Panasonic - ECG	ECA-1HM220	Yes		
C9A,B,C (12V)	2	Electrolytic cap	1000uF, 16V	10%	10x20mm, LS=5mm	UCC, Panasonic	TBD	Yes		12V version
C9A,B,C (5V)	2	Electrolytic cap	1,200uF, 10V	10%	10x20mm, LS=5mm	UCC	EKZE100ELL122MJ20S	Yes		5V version
R1 (Optional)	1	# 22 bare wire jumper	(Wire Jumper)		LS=7.5mm			Yes		
R8	1	Resistor, 2W, metal film	47K, 1W	10%	Axial lead; LS=20mm	Panasonic - ECG	ERG-2SJ473A	Yes		
R4, R5	2	Resistor, 1/2W metal film	1 Meg, 1/2W	10%	Axial lead; LS=12.5mm	Ohmite, Dale	TBD	Yes		
R7	1	Resistor, 1/2W metal film	15 Meg, 1/2W	10%	Axial lead; LS=12.5mm	AVX, Vishay, Dale	TBD	Yes		
R9A, B	2	Resistor, 1/2W metal film	1.8 ohm, 1/2W	5%	Axial lead; LS=12.5mm	AVX, Vishay, Dale	TBD			
R13	1	Resistor, 1/4W metal film	33 ohms, 1/4W	10%	Axial lead; LS=10mm	AVX, Vishay, Dale	TBD			
R2, R3	2	Resistor, 1/4W SMD	5.6K	5%	SMD 1206	AVX, Vishay, Dale	TBD			
R6	1	Resistor, 1/4W SMD	510K	5%	SMD 1206	AVX, Vishay, Dale	TBD	Yes		
R10	1	Resistor, 1/4W SMD	2.4K	5%	SMD 1206	AVX, Vishay, Dale	TBD	Yes		
R11	1	Resistor, 1/4W SMD	Zero ohms	5%	SMD 1206	AVX, Vishay, Dale	TBD			
R12	1	Resistor, 1/4W SMD	2.0 ohms	5%	SMD 1206	AVX, Vishay, Dale	TBD			
R15	1	Resistor, 1/4W SMD	15K	5%	SMD 1206	AVX, Vishay, Dale	TBD			
R16	1	Resistor, 1/4W SMD	20K	5%	SMD 1206	AVX, Vishay, Dale	TBD			
R18	1	Resistor, 1/4W SMD	10K	5%	SMD 1206	AVX, Vishay, Dale	TBD			
R14 (12Vout)	1	Resistor, 1/4W SMD	1K	5%	SMD 1206	AVX, Vishay, Dale	TBD	Yes		
R14 (5Vout)	1	Resistor, 1/4W SMD	240 ohms	5%	SMD 1206	AVX, Vishay, Dale	TBD	Yes		
R17 (12Vout)	1	Resistor, 1/4W SMD	39K	5%	SMD 1206	AVX, Vishay, Dale	TBD	Yes		
R17 (5Vout)	1	Resistor, 1/4W SMD	10K	5%	SMD 1206	AVX, Vishay, Dale	TBD	Yes		
F1	1	Fuse, TR-5 style	2A		TR-5, LS=5mm	Minifuse	TBD	Yes		
L1A/B	1	Inductor (EMI choke)	820 uH, 500 mA		See Wurth Drawing	Wurth Magnetics	7447728215	Yes		
T1 (12Vout)	1	Transformer	E20/10/6 core		See Mag Drawing	ICE Magetics	TO12157	Yes		
						Wurth Electronics	750313861			
T1 (5Vout)	1	Transformer	E20/10/6 core		See Mag Drawing	ICE Magetics	TO09151-1	Yes		
						Wurth Electronics	750313860			
J1, J2	2	Screw Terminal			LS = 0.2"	DigiKey	# 281-1435-ND	Yes		
D8 Heatsink	1	Clip-on Heatsink	(TO-220)		0.52" x 0.52" x 0.75"H	Mouser (Aavid)	532-576802B00 or equiv.			

Yellow indicates values for 12Vout version
Green indicates optional component - generally not stuffed

References

ON Semiconductor data sheet for NCP1126/1129 monolithic switcher.

ON Semiconductor Design Notes DN05012, DN05017, DN05018, DN05028, DN05029

ON Semiconductor Application Note AND8489

Disclaimer: ON Semiconductor is providing this design note "AS IS" and does not assume any liability arising from its use; nor does ON Semiconductor convey any license to its or any third party's intellectual property rights. This document is provided only to assist customers in evaluation of the referenced circuit implementation and the recipient assumes all liability and risk associated with its use, including, but not limited to, compliance with all regulatory standards. ON Semiconductor may change any of its products at any time, without notice.

Design note created by Frank Cathell; e-mail: f.cathell@onsemi.com