



ON Semiconductor

Universal Input, 5 W, LED Ballast

Device	Application	Input Voltage	Output Power	Topology	I/O Isolation
NCP1013	Solid State Lighting	85 – 265 Vac	5 W	Flyback	Yes

Other Specifications				
		Output 1		
Output Voltage		10 Vmax		
Nominal Current		700 mA		

PFC (Yes/No)	No
Target Efficiency	65 % at nominal load
Max Size	58 x 30 x 19 mm
Operating Temp Range	0 to +70°C (open frame)
Cooling Method/Supply Orientation	Convection
Signal Level Control	No

Circuit Description

The controller used in this application is a low cost monolithic design, the NCP1013. This, and the other members of the family, from the NCP1010 to the NCP1014, allow for the design of low cost, yet fully featured, switched mode power supplies. They integrate many peripheral circuits, from start-up to current limit, whilst also adding the ability to run directly from the HV bus, thus obviating the need for a bias winding, and an overload feature ensuring low dissipation in overload and short-circuit.

The design comprises an input filter, bridge rectifier (using low cost 1N4007 diodes), bulk capacitors and line inductor in π -filter arrangement, the power stage, rectifier diode and smoothing capacitors. Feedback is CVCC, constant current drive for the LED's with a constant voltage in the event of an open circuit output.

Key Features

- Wide input voltage range – 85 Vac to 265 Vac
- Small size, and low cost
- Good line regulation
- High efficiency
- Overload and short circuit protection.

Number of LED's in series.	LED Current		
	350 mA	700 mA	1 A
LUXEON® I	2	#NOTE1	
LUXEON® III	2	2	1
LUXEON® V	1	1	#NOTE1
LUXEON® K2	2	2	1
LUXEON® Rebel	2	2	1
V _z (D7)	9V1	8V2	5V1
R3 & R4	3R6	1R8	1R2

#NOTE1: Out of LED specification.

DN06027/D

Schematic

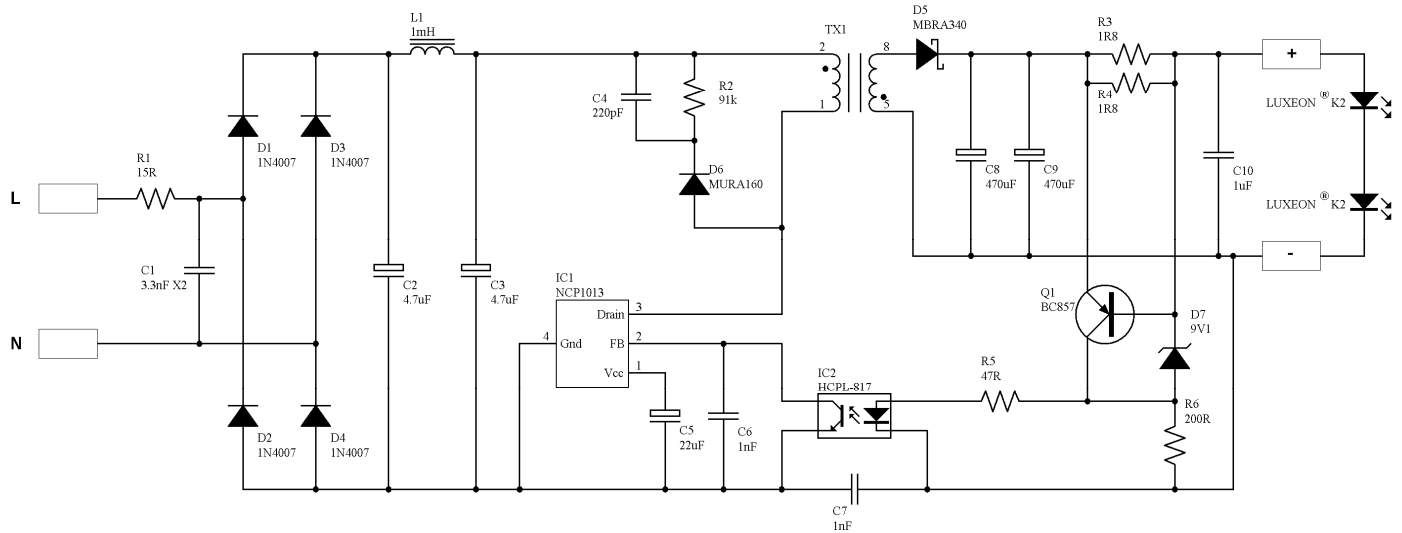

LED Current

The light output of an LED is determined by the forward current so the control loop will be constant current, with a simple Zener to limit the maximum output voltage.

For a white LUXEON® K2 the VI characteristics are:

I_F	V_F
350 mA	3.42 V
700 mA	3.60 V
1000 mA	3.72 V
1500 mA	3.85 V

Driving two LED's at 700 mA thus gives an output power of 5.04 W at 7.2 V.

Inductor selection

In a flyback converter the inductance required in the transformer primary is dependant on the mode of operation and the output power. Discontinuous operation requires lower inductance but results in higher peak to average current waveforms, and thus higher losses. For low power designs, such as this ballast, the inductance is designed to be just continuous (or just discontinuous) under worst case conditions, that is minimum line and maximum load.

The specification for this ballast is as follows:

- Universal input – 85 VAC to 265 VAC
- 5 W output power
- 700 mA output current

This gives us a minimum DC input voltage of 120 V, there will be some sag on the DC bulk capacitors so an

The output current is sensed by a series resistance, once the voltage drop across this reaches the base-emitter threshold of the PNP transistor current flows in the opto-coupler diode and thus in the FB pin of the NCP101x.

The LED current is thus set by:

$$I_{LED} = \frac{0.6V}{R_{SENSE}} \dots\dots\dots (Eq.1)$$

Total sense resistor power dissipation is:

$$P_D = I_{LED} \times 0.6V \dots\dots\dots (Eq.2)$$

So for 700 mA we need a 0.9 Ω sense resistor capable of dissipating 420 mW, two 330 mW surface mount resistors, 1.8 Ω each in parallel, are used.

allowance will be made for this by using 100 V as the minimum input voltage.

Assuming efficiency (η) of 85% we get an input power of:

$$P_{IN} = \frac{P_{OUT}}{\eta} = 5.9 W \dots\dots\dots (Eq.3)$$

At a switching frequency of 100 kHz this gives an energy per cycle requirement, that is the energy that must be stored in the primary inductance on each cycle, of:

$$E = \frac{P}{f_{SW}} = \frac{5.9}{100 \times 10^3} = 59 \mu J \dots\dots\dots (Eq.4)$$

For an inductor:

$$E = \frac{1}{2} LI^2 \dots\dots\dots (Eq.5)$$

Also:

$$V = L \frac{di}{dt} \dots\dots\dots(\text{Eq.6})$$

Rearranging and combining (Eq.5) and (Eq.6) gives:

$$L = \frac{V^2 dt^2}{2E} \dots\dots\dots(\text{Eq.7})$$

Where;

V is $V_{IN(min)} = 100$ V,

E is the energy per cycle = 59 μ J

and dt is the on time; $dt = \frac{\delta}{f_{SW}} \dots\dots\dots(\text{Eq.8})$

For a flyback topology the duty cycle is:

$$\delta = \frac{V_{OUT}}{\frac{V_{IN}}{N} + V_{OUT}} \dots\dots\dots(\text{Eq.9})$$

where N is the transformer turns ratio.

For the NCP101x family of regulators the turn's ratio is determined from the constraints of not exceeding the 700 V maximum rating on the DRAIN pin, and also not taking the DRAIN pin below ground.

$$N \times (V_{OUT} + V_f) + V_{IN(max)} + V_{leak} \leq 700 \text{ (Eq.10)}$$

Or

$$N \leq \frac{(700 - V_{IN(max)} - V_{leak})}{(V_{OUT} + V_f)} \dots\dots\dots(\text{Eq.11})$$

And

$$N \times (V_{OUT} + V_f) \leq V_{IN(min)} \dots\dots\dots(\text{Eq.12})$$

Or

$$N \leq \frac{V_{IN(min)}}{(V_{OUT} + V_f)} \dots\dots\dots(\text{Eq.13})$$

Where:

$V_{IN(max)}$ is the maximum rectified input = 375 V.

$V_{IN(min)}$ is the minimum rectified input = 100 V.

V_{OUT} is 7.2 V (5 W @ 700 mA).

V_{leak} is the leakage spike associated with the leakage inductance of the transformer. A well constructed transformer with a low leakage inductance and some snubbing of the DRAIN pin will keep this value down. A figure of 80 V will allow for a safety margin.

V_f is the forward drop of the output rectifier diode, in this case a Schottky so 0.5 V.

We therefore get $N < 32$ from (Eq.11) and $N < 12.9$ from (Eq.13), clearly we need to use the lower figure of 12.9.

Putting $N=12.9$ and $V_{IN} = 100$ V into (Eq.9) we get $\delta = 0.499$, and from (Eq.8), $dt = 4.99 \mu$ s. This gives us, from (Eq.7), the minimum inductance required which is 2.1 mH. We shall use 2.3 mH.

We can now establish the peak primary current and select the correct member of the NCP101x family.

Rearranging (Eq.6) we get:

$$di = \frac{Vdt}{L} \dots\dots\dots(\text{Eq.14})$$

Thus $di = 217$ mA which, as stated earlier, is equal to I_{PK} in discontinuous mode.

	$I_{PK(min)}$	$I_{PK(nom)}$	$I_{PK(max)}$
NCP1010 ^{#1}	90	100	110
NCP1011 ^{#1}	225	250	275
NCP1012 ^{#2}	225	250	275
NCP1013 ^{#2}	315	350	385
NCP1014 ^{#2}	405	450	495

^{#1} 22 Ω FET

^{#2} 11 Ω FET

Whilst the NCP1011 has a current limit inception point between 225 mA and 275 mA there is little margin for spikes and parameter variances so the NCP1013 will be the regulator used.

IC Consumption

The IC internal consumption is quoted as a maximum 1.15 mA, typically 0.95 mA. This is dissipated as loss in the regulator itself and is in addition to our estimated 85% efficiency that just relates to the transformer throughput. This loss goes from typically 115 mW at 85 Vac to 356 mW at 265 Vac with a maximum, at 265 VAC, of 431 mW.

DN06027/D
MAGNETICS DESIGN DATA SHEET

Project / Customer: ON Semiconductor/Future Lighting Solution
 Part Description: 5 W Transformer
 Schematic ID: -
 Core Type: -
 Core Gap: Gap for 2.3 mH
 Inductance: 2.3 mH
 Bobbin Type: -

Windings (in order):

Winding # / type	Turns / Material / Gauge / Insulation Data
N1, Primary	Start on pin 1 and wind 128 turns, of Grade 2 ECW, in one neat layer across the entire bobbin width. Finish on pin 2.
N2, Secondary	Start on pin 8 and wind 10 turns, of Tex E triple insulated wire or equivalent, distributed evenly across the entire bobbin width. Finish on pin 5. Sleeving and insulation between primary and secondary as required to meet requirements of double insulation.

Primary leakage inductance (pins 5 and 8 shorted together) to be < 70 μ H

NIC part number: NLT181814W2NT128UT10P8C2F

Hipot: 3 kV between pins 1,2 and pins 5,8 for 60 secs.

Schematic

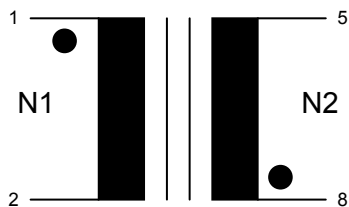

Lead Breakout / Pinout

(Bottom View – looking at pins)

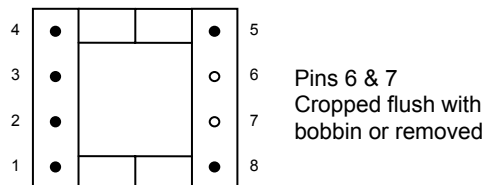

DN06027/D

Bill of Materials

Ref.	Part Type	Qty. per	Description	Manufacturer	Part No.	Comment
C1	3.3nF, 250/275VAC	1	X2-class EMI suppression capacitor	NIC	NPX332M275V X2 (Alt. SMD: NPX332M275V X2F)	250VAC/275VAC X2
C10	1µF, 16V	1	Ceramic chip capacitor	NIC	NMC1206X7R105K16	16V X7R
C2 & C3	4.7µF, 400V	2	General purpose high voltage electrolytic	NIC	NREH4R7M400V 10X16F (Alt. SMD: NACV4R7M400V 10X10.8TR13F)	
C4	220pF, 1kV	1	Ceramic chip capacitor	NIC	NMC-H1210NP0221K1KVTRPF	1kV
C5	22µF, 16V	1	General purpose low voltage electrolytic	NIC	NRSA220M16V5X11F (Alt. SMD: NACE220M16V4X5.5TR13F)	
C6	1.0nF, 10V	1	Ceramic chip capacitor	NIC	NMC0805X7R102K10	10V X7R
C7	1nF	1	Ceramic Y Capacitor	Murata	DE1E3KX102MN4AL01	Y1
C8 & C9	470µF	2	Miniature low impedance electrolytic	NIC	NRSH471M16V8X11.5F (Alt. SMD: NACK471M35V 12.5X14TR13F)	0.06Ohms
D1 - D4	1N4007	4	Axial Lead Standard Recovery Rectifier 1A, 1000V	ON Semiconductor	1N4007RLG	1000V
D5	MBRA340	1	40V 3A Schottky diode	ON Semiconductor	MBRA340T3G	
D6	MURA160	1	600V 1A Ultrafast rectifier	ON Semiconductor	MURA160T3G	
D7	9V1	1	200mW SOD-323 Zener diode	ON Semiconductor	MM3Z9V1T1G	9.1V, 5%
IC1	NCP1013	1	Self-Supplied Monolithic Sw itcher for Low Standby-Pow er Offline SMPS	ON Semiconductor	NCP1013ST100T3G	100kHz
IC2	HCPL-817	1	Opto-coupler HCPL-817 - Wide pitch	Agilent	HCPL-817-W0AE	Wide pitch
L1	1mH, 250mA	1	Power inductor	Coilcraft	RFB0807-102L (Alt. SMD: NIC NPIS104T102KTRF)	250mA
Q1	BC857	1	General purpose PNP	ON Semiconductor	BC857ALT1G	
R1	15R, 1W	1	Axial lead carbon film resistor	NIC	NRC100J150TRF	1W
R2	91k, 1W	1	Axial lead carbon film resistor	NIC	NRC100J913TRF	1W
R3 & R4	1.8R	2	Resistor thick film NRC	NIC	NRC25J1R8TR	0.33W
R5	47R	1	Resistor thick film NRC	NIC	NRC10J470TR	0.125W
R6	200R	1	Resistor thick film NRC	NIC	NRC10J201TR	0.125W
TX1	Custom	1	5W Flyback transformer	NIC	NLT181814W2NT128UT10P8C2F	

All parts can be ordered from Future Electronics

Component locations

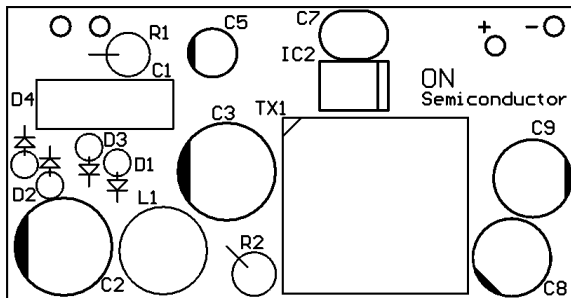

Top view.

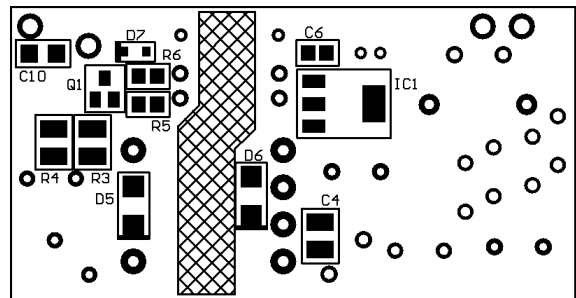

Bottom view.

DN06027/D PCB Tracks

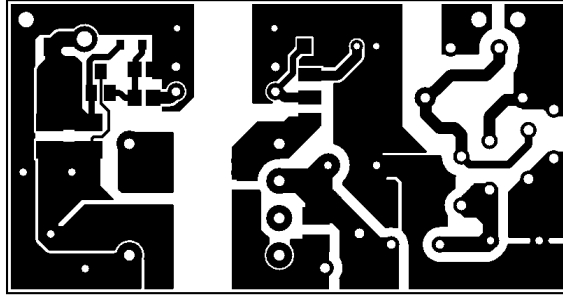

Results

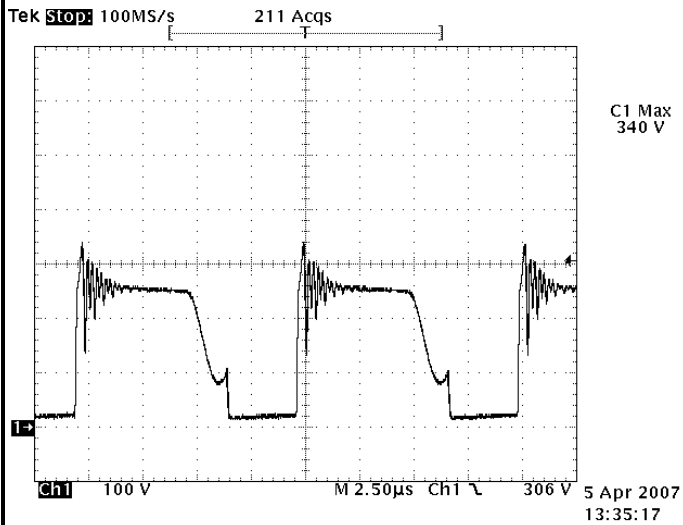

Drain waveform at 110 VAC

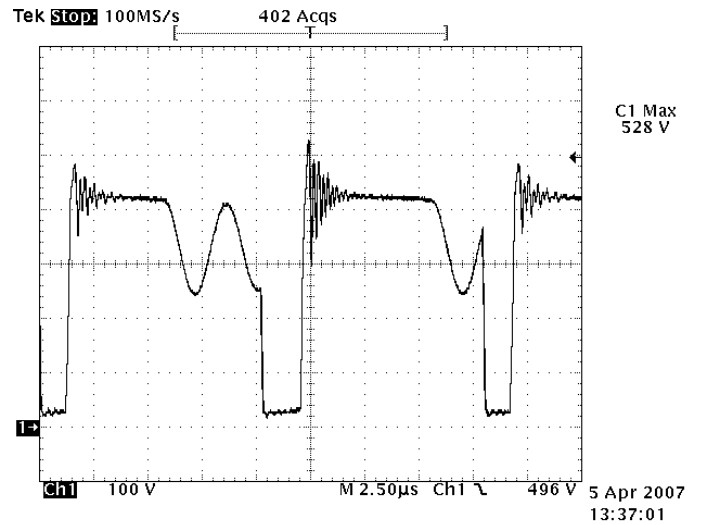

Drain waveform at 230 VAC

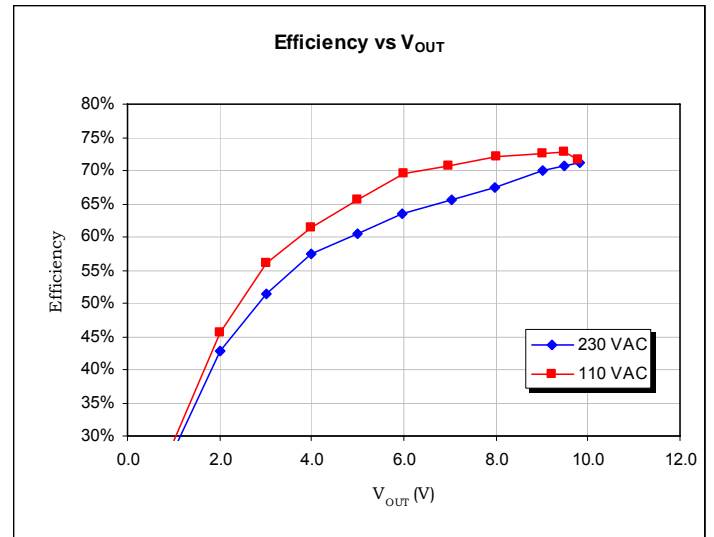
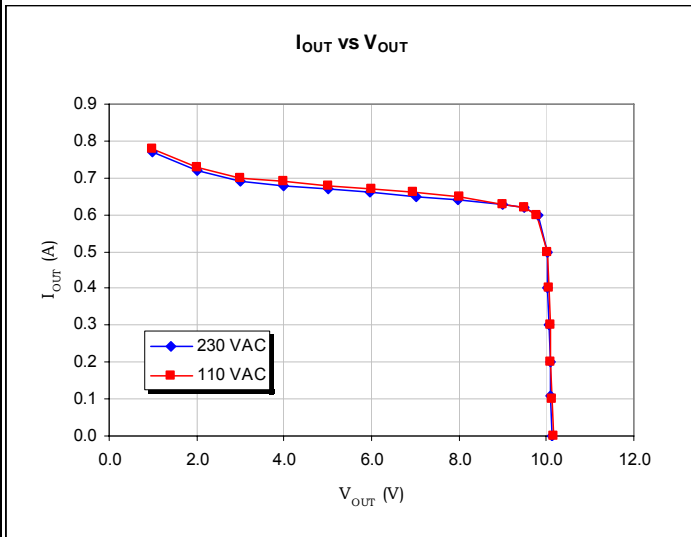

© 2008 ON Semiconductor.

Disclaimer: ON Semiconductor is providing this design note "AS IS" and does not assume any liability arising from its use; nor does ON Semiconductor convey any license to its or any third party's intellectual property rights. This document is provided only to assist customers in evaluation of the referenced circuit implementation and the recipient assumes all liability and risk associated with its use, including, but not limited to, compliance with all regulatory standards. ON Semiconductor may change any of its products at any time, without notice.

Design note created by Anthony Middleton, e-mail: Anthony.Middleton@onsemi.com