

# 单通道高侧栅极驱动 IC

## FAN73611

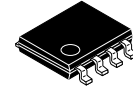

SOIC8  
(8-SOP)  
CASE 751EG

### 说明

FAN73611 是一款单片高侧栅极驱动 IC，可以驱动工作电压最高达 +600 V 的 MOSFET 和 IGBT。onsemi 的高压工艺和共模噪声消除技术可使高侧驱动器在高 dv/dt 噪声环境下稳定运行。先进的电平转换电路，能使高端栅极驱动器的工作电压在  $V_{BS} = 15\text{ V}$  时高达  $V_S = -9.8\text{ V}$  (典型值)。当  $V_{DD}$  或  $V_{BS}$  小于指定阈值电压时，UVLO 电路可防止发生故障。输出驱动器的典型源电流/灌电流分别为 250 mA/500 mA，适于等离子显示板 (PDP) 应用、电机驱动逆变器和开关电源应用。

### 特性

- 浮动通道可实现高达 +600 V 的自举运行
- 250 mA/500 mA 的典型源电流/灌电流驱动能力
- 共模 dv/dt 噪声消除电路
- 3.3 兼容 V 和 5 V 输入逻辑
- 输出与输入信号同相
- $V_{DD}$  和  $V_{BS}$  欠压锁定
- 8- 引脚小尺寸封装 (SOP)
- This is a Pb-Free Device

### 应用

- 电子镇流器
- 开关电源 SMPS

### 相关资源

- [AN-6076 - 高压栅极驱动 IC 自举电路的设计与应用指南](#)
- [AN-9052 - 自举元件选择的设计指南](#)
- [AN-8102 - 避免 HVIC 栅极驱动器应用中的短脉冲宽度问题的建议](#)

### MARKING DIAGRAM

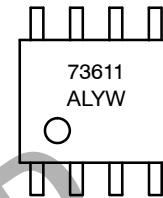

73611 = Device Code  
A = Assembly Site  
L = Wafer Lot Number  
YW = Assembly Start Week

### ORDERING INFORMATION

See detailed ordering and shipping information on page 11 of this data sheet.

# FAN73611

## 典型应用电路



图 1. 降压直流-直流转换器应用

## 内部框图

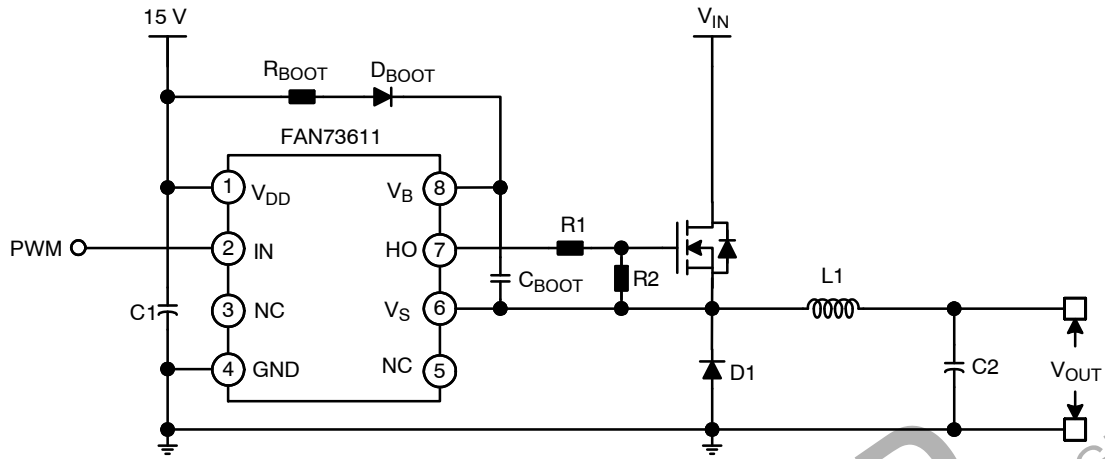

图 2. 功能框图

# FAN73611

## 引脚配置

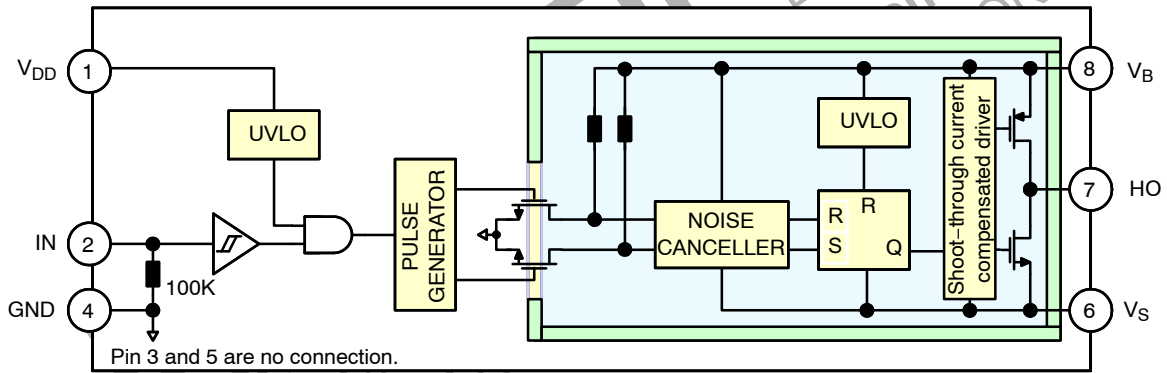

图 3. 引脚配置 (俯视图)

### 引脚定义

引脚号	名称	描述
1	V <sub>DD</sub>	电源电压
2	IN	高侧栅极驱动器输出的逻辑输入
3	NC	无连接
4	GND	接地
5	NC	无连接
6	V <sub>S</sub>	高侧浮动电源电压返回
7	HO	高侧驱动输出
8	V <sub>B</sub>	高侧浮动电源

DISCONTINUED  
THIS DEVICE IS NOT RECOMMENDED FOR NEW DESIGN  
PLEASE CONTACT YOUR onsemi REPRESENTATIVE FOR INFORMATION

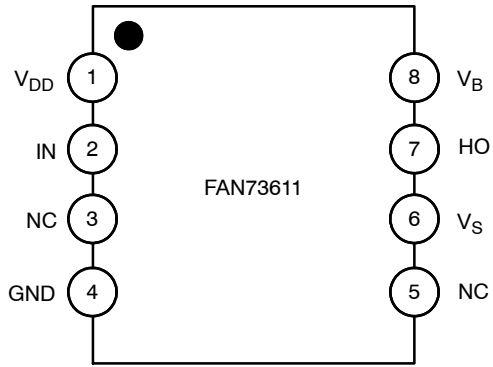
# FAN73611

绝对最大额定值 (除非另有说明,  $T_A = 25^\circ\text{C}$ 。)

符号	参数	最小值	最大值	单位
$V_S$	高侧浮动偏置电压	$V_B - 25$	$V_B + 0.3$	V
$V_B$	高侧浮动电源电压	-0.3	625.0	V
$V_{HO}$	高侧浮动输出电压	$V_S - 0.3$	$V_B + 0.3$	V
$V_{DD}$	低端和逻辑电源电压	-0.3	25.0	V
$V_{IN}$	逻辑输入电压	-0.3	$V_{CC} + 0.3$	V
$dV_S/dt$	允许的偏置电压变化速率	-	$\pm 50$	V/ns
$P_D$	功耗 (注意 1, 2, 3)	-	0.625	W
$\theta_{JA}$	热阻	-	200	$^\circ\text{C}/\text{W}$
$T_J$	结温	-55	+150	$^\circ\text{C}$
$T_{STG}$	存储温度	-55	+150	$^\circ\text{C}$

Stresses exceeding those listed in the Maximum Ratings table may damage the device. If any of these limits are exceeded, device functionality should not be assumed, damage may occur and reliability may be affected.

(参考译文)

如果电压超过最大额定值表中列出的值范围, 器件可能会损坏。如果超过任何这些限值, 将无法保证器件功能, 可能会导致器件损坏, 影响可靠性。

1. 安装到 76.2 x 114.3 x 1.6 mm PCB 板上 (FR-4 环氧玻璃材料)。

2. 参照下列标准:

JESD51-2: 集成电路热测试方法环境条件—自然对流和

JESD51-3: 含铅表面贴装封装的低有效导热系数测试板。

3. 任何情况下, 都不得超过功耗  $P_D$ 。

## 推荐工作额定值

符号	参数	最小值	最大值	单位
$V_B$	高侧浮动电源电压	$V_S + 10$	$V_S + 20$	V
$V_S$	高侧浮动电源偏置电压	$6 - V_{DD}$	600	V
$V_{HO}$	高侧输出电压	$V_S$	$V_B$	V
$V_{IN}$	逻辑输入电压	GND	$V_{DD}$	V
$V_{DD}$	电源电压	10	20	V
$T_A$	操作环境温度	-40	+125	$^\circ\text{C}$

Functional operation above the stresses listed in the Recommended Operating Ranges is not implied. Extended exposure to stresses beyond the Recommended Operating Ranges limits may affect device reliability.

(参考译文)

高于推荐工作范围表格中所列电压时, 不保证能够正常运行。长时间在推荐工作范围表格中规定范围以外的电压下运行, 可能会影响器件的可靠性。

# FAN73611

电气特性 ( $V_{BIAS} (V_{DD}, V_{BS}) = 15.0\text{ V}$  且  $T_A = 25^\circ\text{C}$ 。  $V_{IN}$  和  $I_{IN}$  参数以 GND 作为基准。  $V_O$  和  $I_O$  参数以  $V_S$  为参考点，适用于对应的输出 HO，除非另有规定。)

符号	特性	测试条件	最小值	典型值	最大值	单位
<b>电源部分</b>						
$I_{QDD}$	$V_{DD}$ 静态电源电流	$V_{IN} = 0\text{ V}$ or $5\text{ V}$ , $C_{LOAD} = 1000\text{ pF}$	-	80	140	$\mu\text{A}$
$I_{PDD}$	$V_{DD}$ 工作电源电流	$C_{LOAD} = 1000\text{ pF}$ , $f_{IN} = 20\text{ KHz}$ , RMS 值	-	80	160	$\mu\text{A}$
$V_{DDUV+}$ $V_{BSUV+}$	$V_{DD}$ 和 $V_{BS}$ 电源欠压正向阈值电压	$V_{DD} = \text{扫描}$ , $V_{BS} = \text{扫描}$	7.8	8.8	9.8	V
$V_{DDUV-}$ $V_{BSUV-}$	$V_{DD}$ 和 $V_{BS}$ 电源欠压负向阈值电压	$V_{DD} = \text{扫描}$ , $V_{BS} = \text{扫描}$	7.3	8.3	9.3	V
$V_{DDHYS}$ $V_{BSHYS}$	$V_{DD}$ 和 $V_{BS}$ 电源欠压锁定滞回电压	$V_{DD} = \text{扫描}$ , $V_{BS} = \text{扫描}$	-	0.5	-	$\mu\text{A}$
$I_{LK}$	偏置电源漏电流	$V_B = V_S = 600\text{ V}$	-	-	10	$\mu\text{A}$
$I_{QBS}$	$V_{BS}$ 静态电源电流	$V_{IN} = 0\text{ V}$ or $5\text{ V}$ , $C_{LOAD} = 1000\text{ pF}$	-	60	100	$\mu\text{A}$
$I_{PBS}$	$V_{BS}$ 工作电源电流	$C_{LOAD} = 1000\text{ pF}$ , $f_{IN} = 20\text{ KHz}$ , RMS 值	-	420	600	$\mu\text{A}$

## 输入逻辑部分

$V_{IH}$	逻辑“1”输入电压 2.5		2.5	-	-	V
$V_{IL}$	逻辑“0”输入电压		-	-	0.8	V
$I_{IN+}$	逻辑输入高电平偏置电流	$V_{IN} = 5\text{ V}$	-	50	75	$\mu\text{A}$
$I_{IN-}$	逻辑输入低电平偏置电流	$V_{IN} = 0\text{ V}$	-	-	2	$\mu\text{A}$
$R_{IN}$	输入下拉电阻		60	100	-	$\text{k}\Omega$

## 栅极驱动器输出部分

$V_{OH}$	高电平输出电压	无负载	-	-	0.1	V
$V_{OL}$	低电平输出电压	无负载	-	-	0.1	V
$I_{O+}$	输出高, 短路脉冲电流	$V_{HO} = 0\text{ V}$ , $V_{IN} = 5\text{ V}$ , $PW \leq 10\ \mu\text{s}$	200	250	-	mA
$I_{O-}$	输出低, 短路脉冲电流	$V_{HO} = 15\text{ V}$ , $V_{IN} = 0\text{ V}$ , $PW \leq 10\ \mu\text{s}$	400	500	-	mA
$V_S$	IN 信号传播到 HO 时允许的 $V_S$ 引脚负电压 $V_{BS}$	$V_{BS} = 15\text{ V}$	-	-9.8	-7.0	V

Product parametric performance is indicated in the Electrical Characteristics for the listed test conditions, unless otherwise noted. Product performance may not be indicated by the Electrical Characteristics if operated under different conditions.

(参考译文)

除非另有说明，“电气特性”表格中列出的是所列测试条件下的产品性能参数。如果在不同条件下运行，产品性能可能与“电气特性”表格中所列性能参数不一致。

## 动态电气特性 (除非另有规定, $V_{DD} = V_{BS} = 15\text{ V}$ , $C_{LOAD} = 1000\text{ pF}$ , 以及 $T_A = 25^\circ\text{C}$ )

符号	参数	工作条件	最小值	典型值	最大值	单位
$t_{on}$	导通传播延时	$V_S = 0\text{ V}$	70	120	170	ns
$t_{off}$	关断传播延时	$V_S = 0\text{ V}$	70	120	170	ns
$t_r$	导通上升时间		-	70	140	ns
$t_f$	关断下降时间		-	30	60	ns

Product parametric performance is indicated in the Electrical Characteristics for the listed test conditions, unless otherwise noted. Product performance may not be indicated by the Electrical Characteristics if operated under different conditions.

(参考译文)

除非另有说明，“电气特性”表格中列出的是所列测试条件下的产品性能参数。如果在不同条件下运行，产品性能可能与“电气特性”表格中所列性能参数不一致。

典型特性



图 4. 开通传输延时与温度的关系



图 5. 关断传输延时与温度的关系

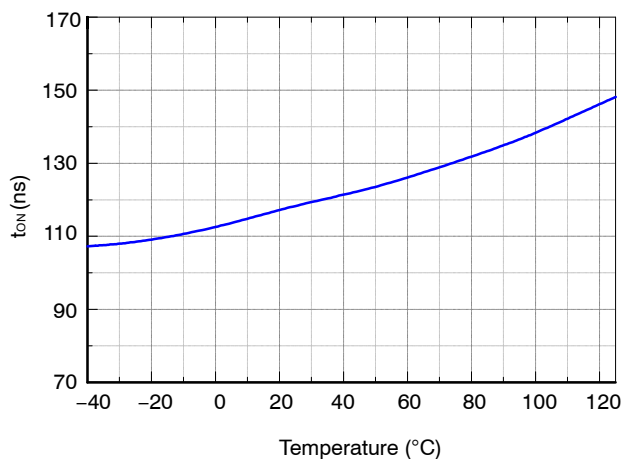

图 6. 开通上升时间与温度的关系

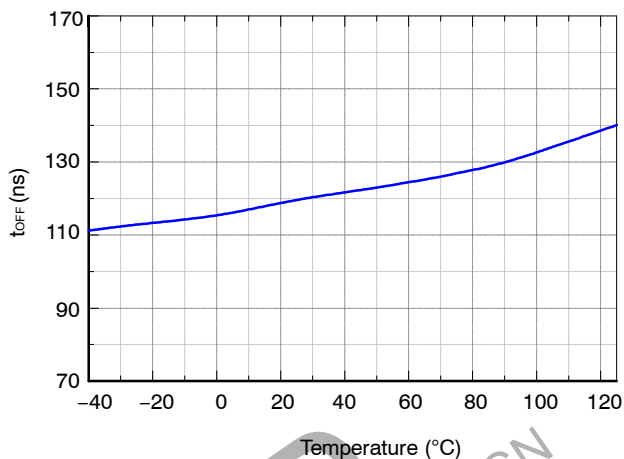

图 7. 导通下降时间与温度的关系

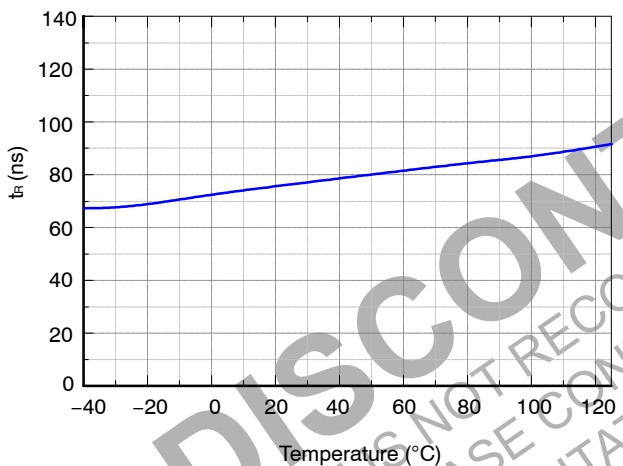

图 8. 静态 V<sub>DD</sub> 电源电流与温度的关系

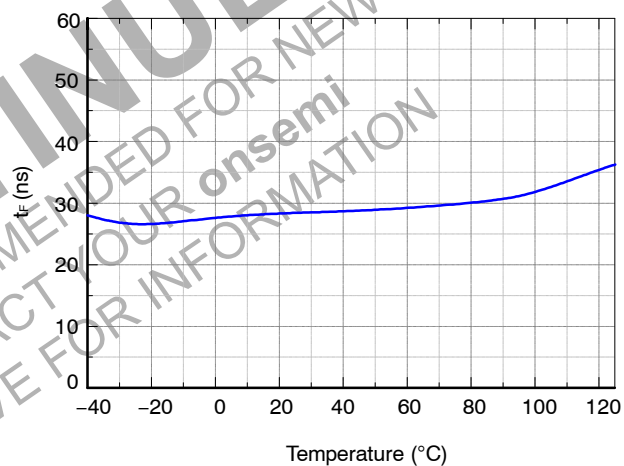

图 9. 静态 V<sub>BS</sub> 电源电流与温度的关系

典型特性 (接上页)

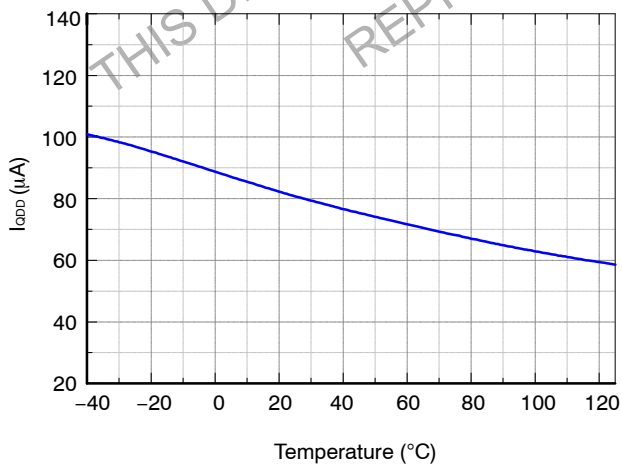

图 10. 工作时 V<sub>DD</sub> 电源电流与温度的关系

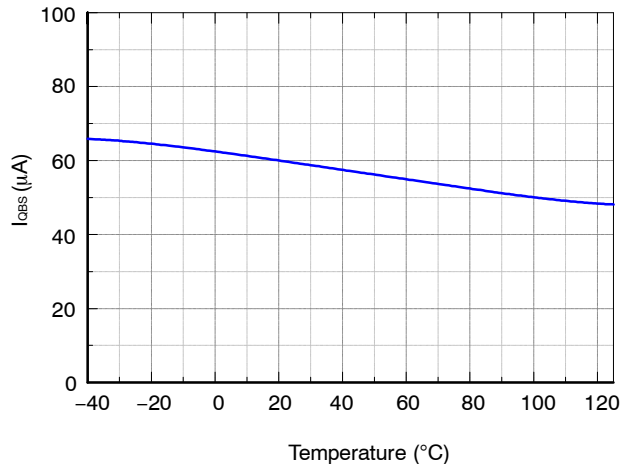

图 11. V<sub>BS</sub> 工作电源电流与温度的关系

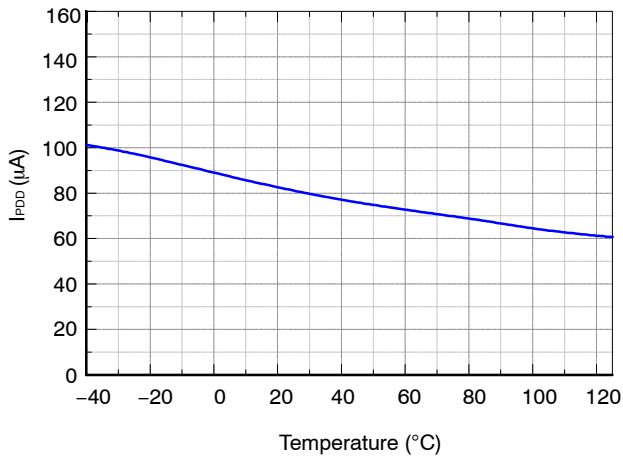

图 12. V<sub>DD</sub> UVLO+ 与温度的关系

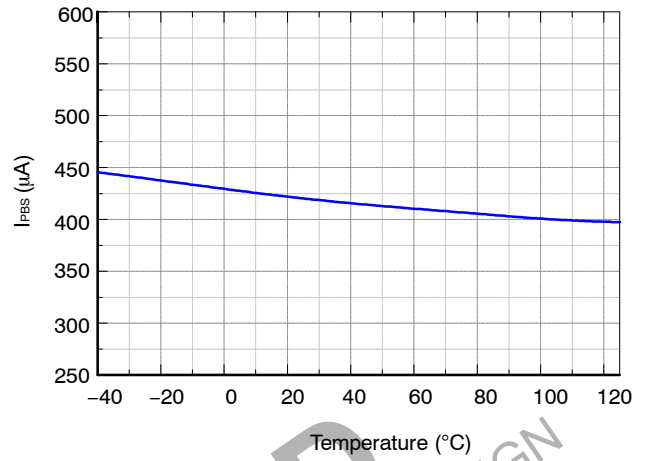

图 13. V<sub>DD</sub> UVLO- 与温度的关系

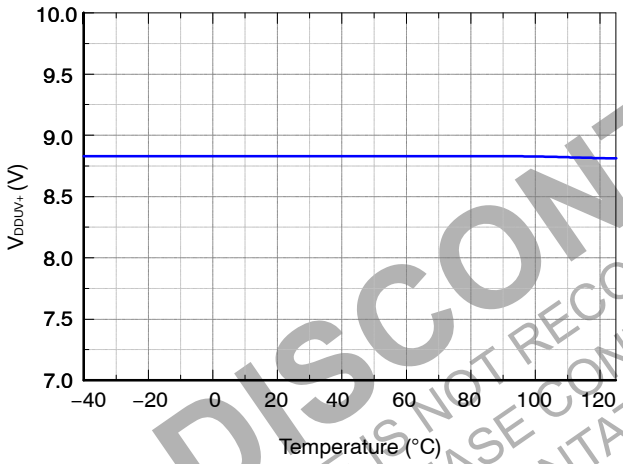

图 14. V<sub>BS</sub> UVLO+ 与温度的关系

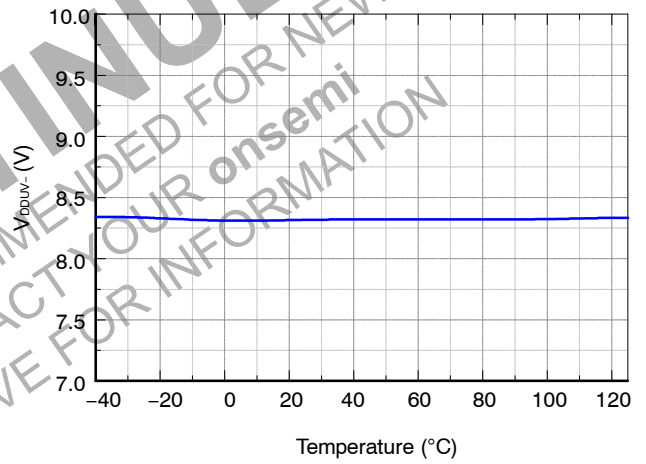

图 15. V<sub>BS</sub> UVLO- 与温度的关系

典型特性 (接上页)

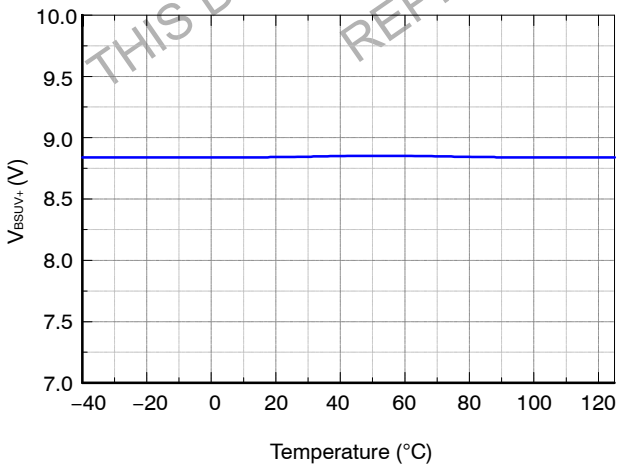

图 16. 逻辑高输入电压与温度的关系

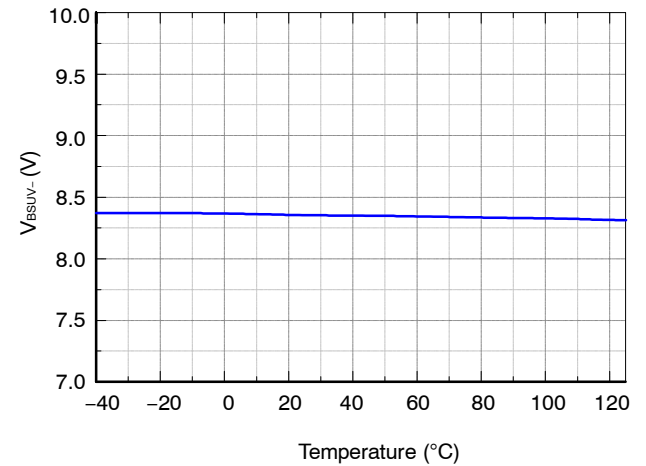

图 17. 逻辑低输入电压与温度的关系

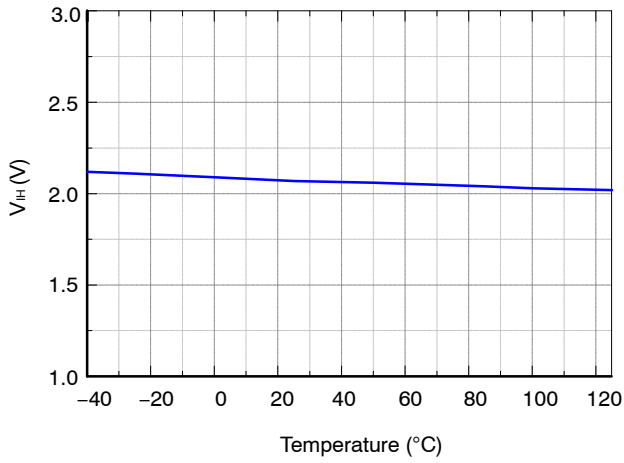

图 18. 逻辑高输入偏置电流与温度的关系

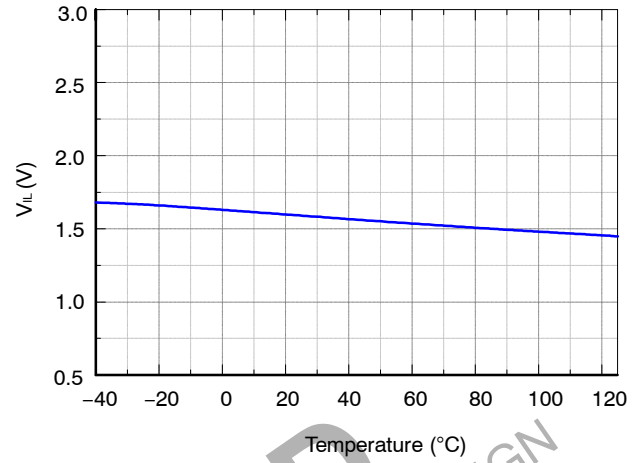

图 19. 输入下拉电阻与温度的关系

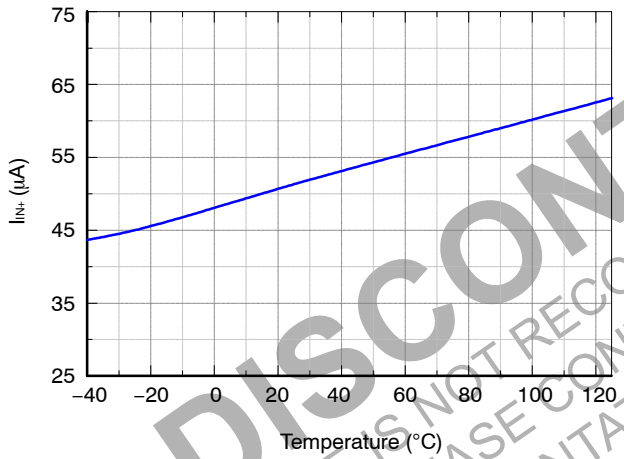

图 20. 高电平输出电压与温度的关系

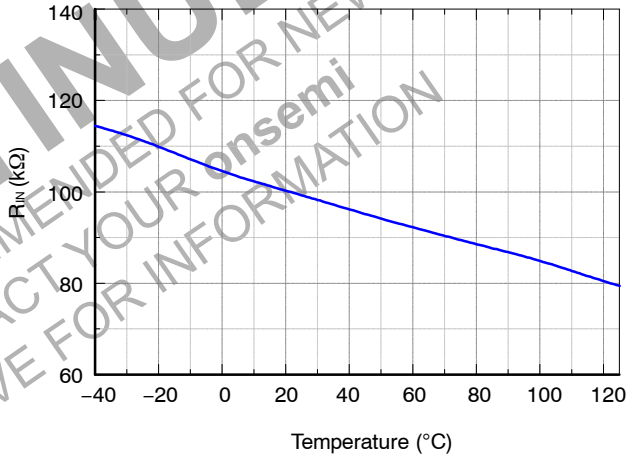

图 21. 低电平输出电压与温度的关系

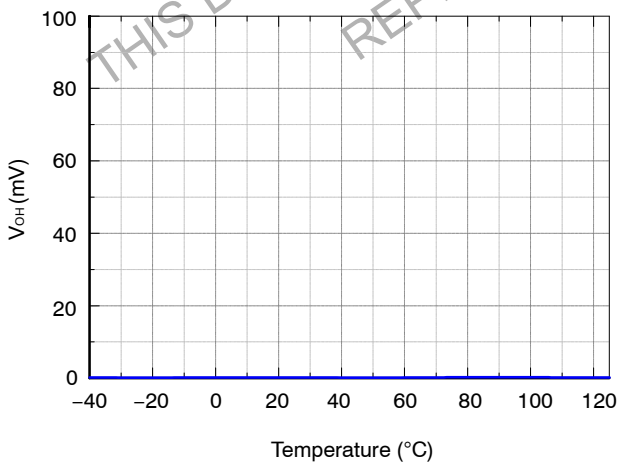

典型特性 (接上页)

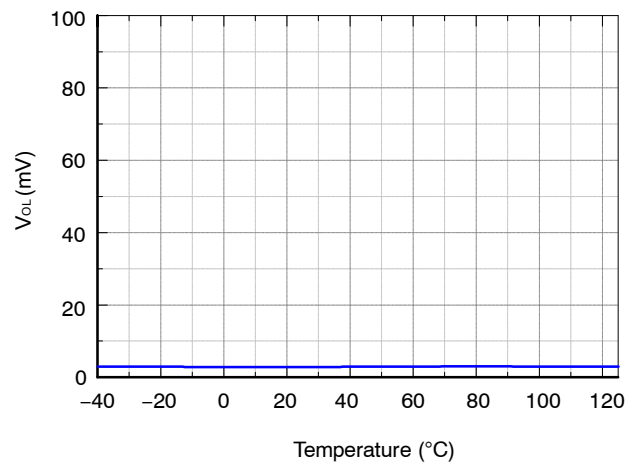

图 22. 容许的负  $V_S$  电压与温度的关系



图 23. 允许负  $V_S$  电压与电源电压

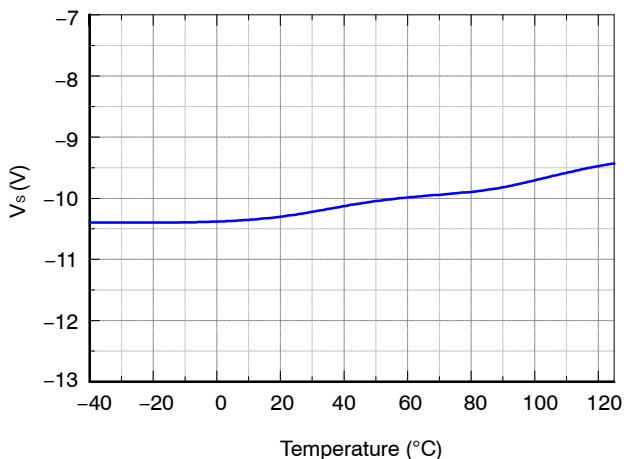

图 24. 导通传播延时与电源电压的关系

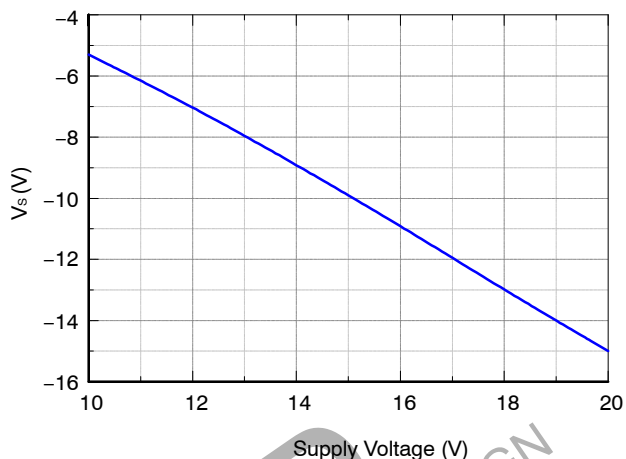

图 25. 关断传播延时与电源电压的关系

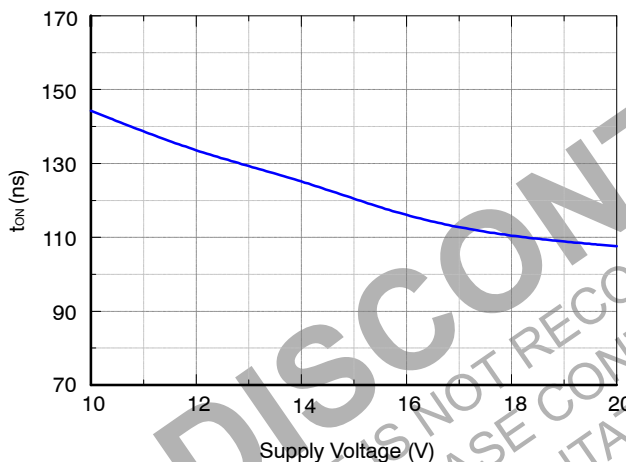

图 26. 开通上升时间与电源电压的关系

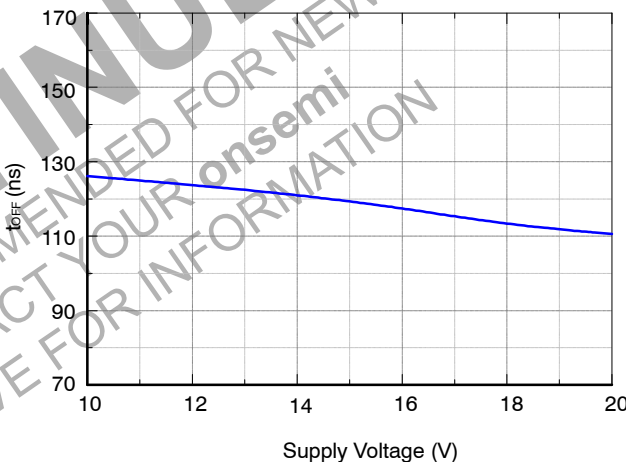

图 27. 关断下降时间与电源电压

典型特性 (接上页)

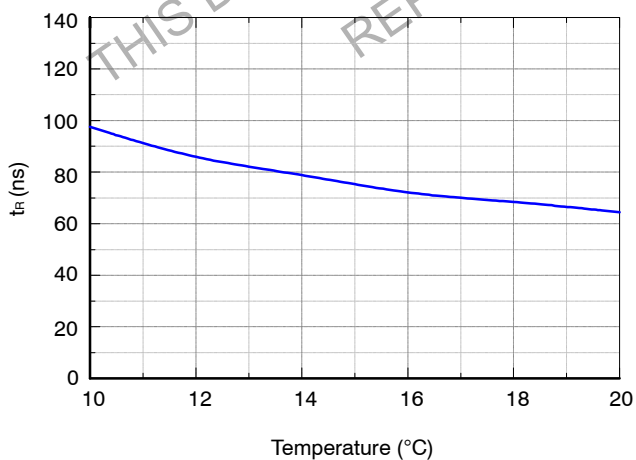

图 28.  $V_{DD}$  静态电源电流与电源电压的关系

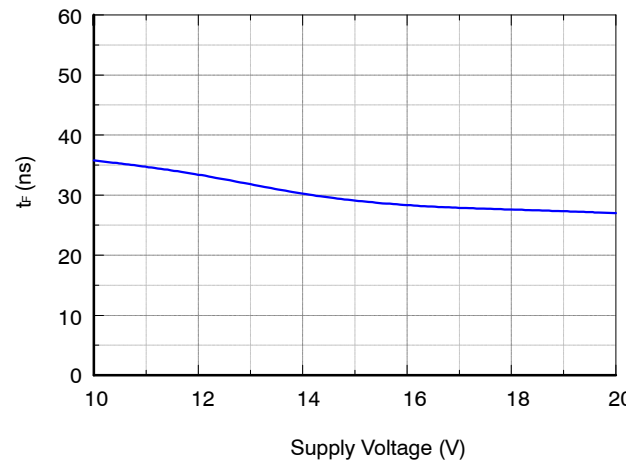

图 29.  $V_{BS}$  静态电源电流与电源电压的关系

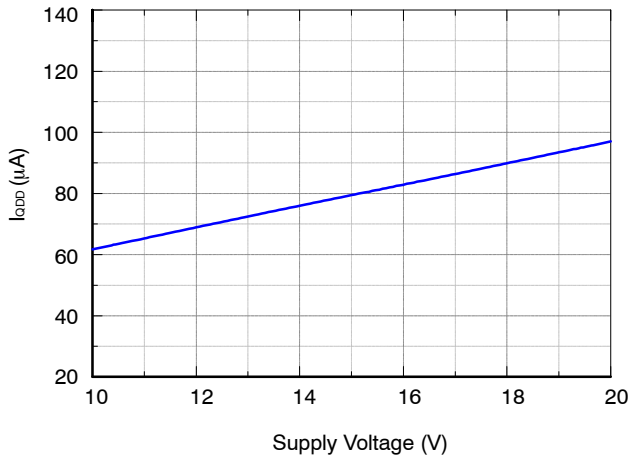

图 30. 工作时  $V_{DD}$  电源电流与电源电压的关系

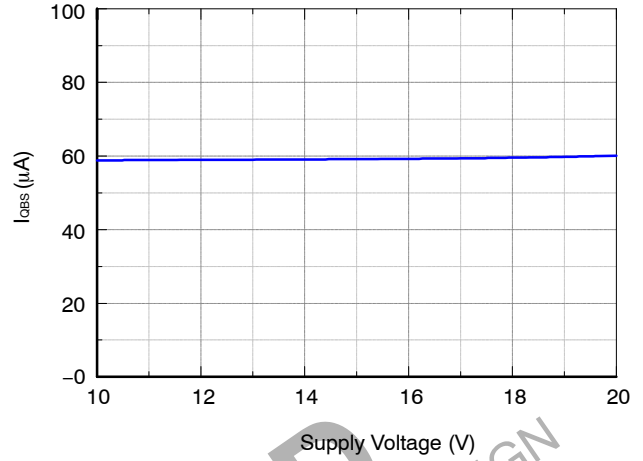

图 31. 工作时  $V_{BS}$  电源电流与电源电压的关系

# FAN73611

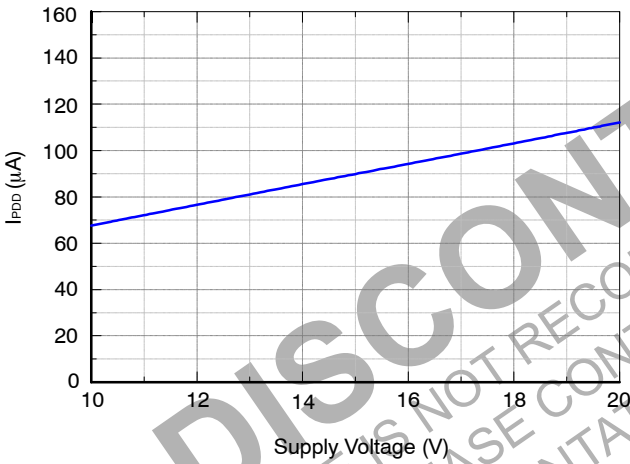
## 开关时间定义

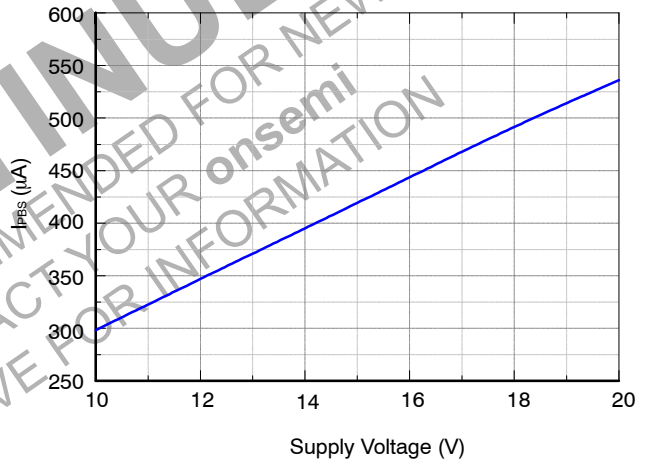

图 32. 开关时间测试电路和波形定义



图 33. 浮动电源电压瞬态测试

### 订购信息

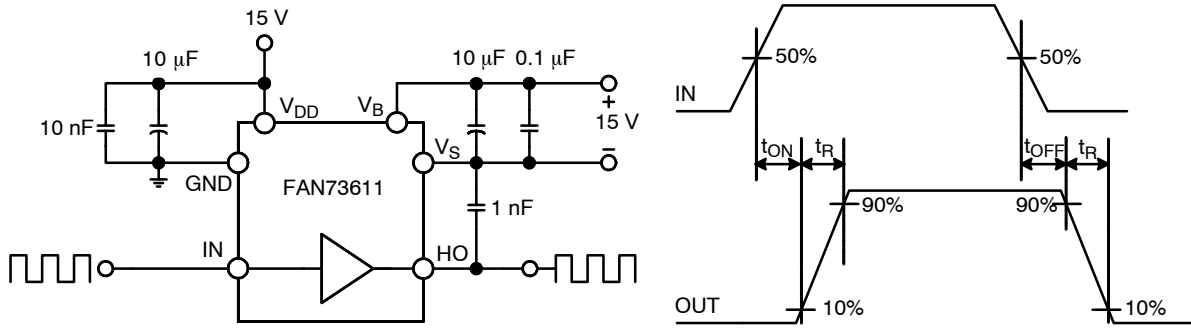
器件	封装	工作温度	描述	Shipping†
FAN73611MX (说明 4)	SOIC8 (8-SOP)	-40°C~+125°C	照明应用	3000 / 卷带和卷盘

†For information on tape and reel specifications, including part orientation and tape sizes, please refer to our Tape and Reel Packaging Specifications Brochure, BRD8011/D.

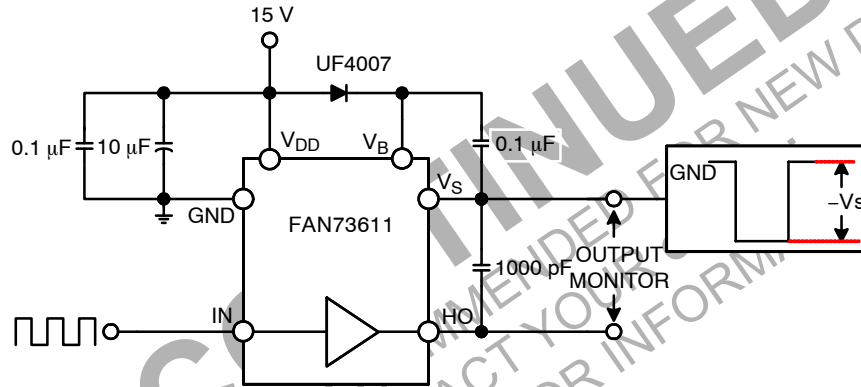
4. 该器件已通过 JESD22A-111 波动焊接测试。

**SOIC8**  
CASE 751EG  
ISSUE O

DATE 30 SEP 2016

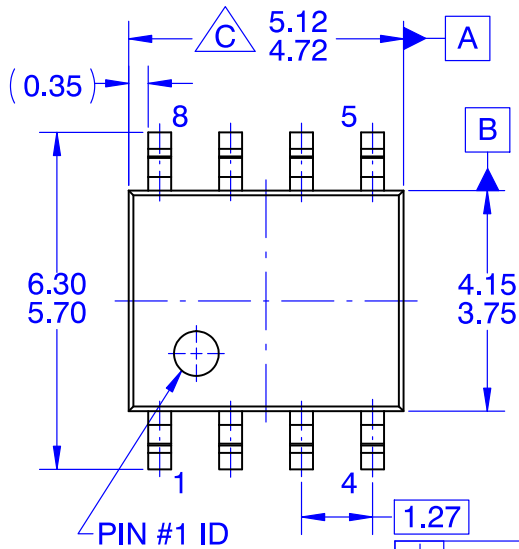

TOP VIEW

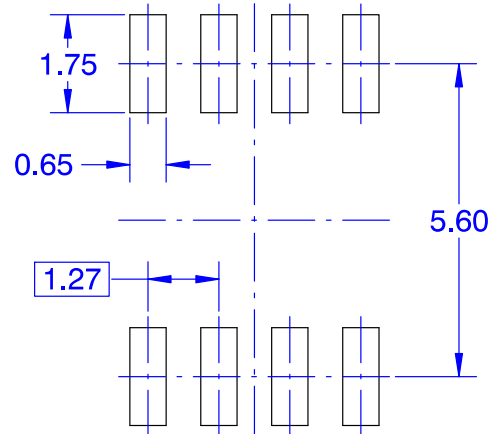

LAND PATTERN RECOMMENDATION

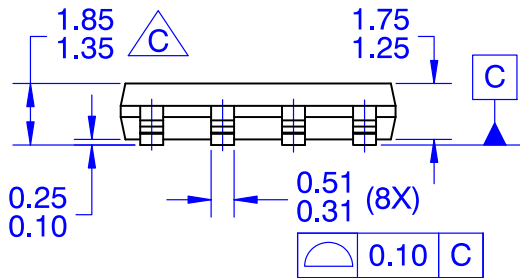

FRONT VIEW

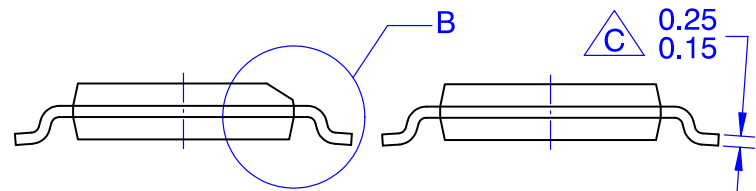

OPTION A  
BEVEL EDGE

OPTION B  
NON-BEVEL EDGE

SIDE VIEW

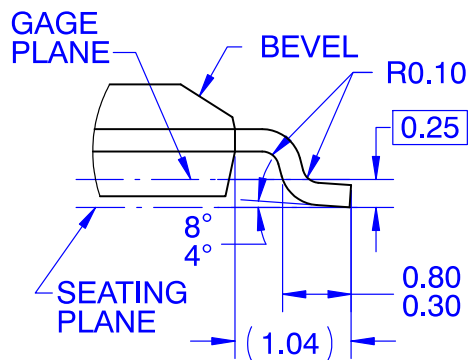

DETAIL "B"  
SCALE 2:1

NOTES: UNLESS OTHERWISE SPECIFIED

- A. THIS PACKAGE CONFORMS TO JEDEC MS-012 VARIATION A EXCEPT WHERE NOTED.
- B. ALL DIMENSIONS ARE IN MILLIMETERS
- $\triangle C$  OUT OF JEDEC STANDARD VALUE
- D. DIMENSIONS ARE EXCLUSIVE OF BURRS, MOLD FLASH AND TIE BAR EXTRUSIONS.
- E. LAND PATTERN AS PER IPC SOIC127P600X175-8M

<b>DOCUMENT NUMBER:</b>	<b>98AON13741G</b>	Electronic versions are uncontrolled except when accessed directly from the Document Repository. Printed versions are uncontrolled except when stamped "CONTROLLED COPY" in red.
<b>DESCRIPTION:</b>	<b>SOIC8</b>	<b>PAGE 1 OF 1</b>

onsemi and ONSEMI are trademarks of Semiconductor Components Industries, LLC dba onsemi or its subsidiaries in the United States and/or other countries. onsemi reserves the right to make changes without further notice to any products herein. onsemi makes no warranty, representation or guarantee regarding the suitability of its products for any particular purpose, nor does onsemi assume any liability arising out of the application or use of any product or circuit, and specifically disclaims any and all liability, including without limitation special, consequential or incidental damages. onsemi does not convey any license under its patent rights nor the rights of others.

**onsemi**, **Onsemi**, and other names, marks, and brands are registered and/or common law trademarks of Semiconductor Components Industries, LLC dba "**onsemi**" or its affiliates and/or subsidiaries in the United States and/or other countries. **onsemi** owns the rights to a number of patents, trademarks, copyrights, trade secrets, and other intellectual property. A listing of **onsemi**'s product/patent coverage may be accessed at [www.onsemi.com/site/pdf/Patent-Marking.pdf](http://www.onsemi.com/site/pdf/Patent-Marking.pdf). **onsemi** reserves the right to make changes at any time to any products or information herein, without notice. The information herein is provided "as-is" and **onsemi** makes no warranty, representation or guarantee regarding the accuracy of the information, product features, availability, functionality, or suitability of its products for any particular purpose, nor does **onsemi** assume any liability arising out of the application or use of any product or circuit, and specifically disclaims any and all liability, including without limitation special, consequential or incidental damages. Buyer is responsible for its products and applications using **onsemi** products, including compliance with all laws, regulations and safety requirements or standards, regardless of any support or applications information provided by **onsemi**. "Typical" parameters which may be provided in **onsemi** data sheets and/or specifications can and do vary in different applications and actual performance may vary over time. All operating parameters, including "Typicals" must be validated for each customer application by customer's technical experts. **onsemi** does not convey any license under any of its intellectual property rights nor the rights of others. **onsemi** products are not designed, intended, or authorized for use as a critical component in life support systems or any FDA Class 3 medical devices or medical devices with a same or similar classification in a foreign jurisdiction or any devices intended for implantation in the human body. Should Buyer purchase or use **onsemi** products for any such unintended or unauthorized application, Buyer shall indemnify and hold **onsemi** and its officers, employees, subsidiaries, affiliates, and distributors harmless against all claims, costs, damages, and expenses, and reasonable attorney fees arising out of, directly or indirectly, any claim of personal injury or death associated with such unintended or unauthorized use, even if such claim alleges that **onsemi** was negligent regarding the design or manufacture of the part. **onsemi** is an Equal Opportunity/Affirmative Action Employer. This literature is subject to all applicable copyright laws and is not for resale in any manner.

## ADDITIONAL INFORMATION

### TECHNICAL PUBLICATIONS:

Technical Library: [www.onsemi.com/design/resources/technical-documentation](http://www.onsemi.com/design/resources/technical-documentation)  
onsemi Website: [www.onsemi.com](http://www.onsemi.com)

### ONLINE SUPPORT: [www.onsemi.com/support](http://www.onsemi.com/support)

For additional information, please contact your local Sales Representative at [www.onsemi.com/support/sales](http://www.onsemi.com/support/sales)

