



Is Now Part of



ON Semiconductor®

To learn more about ON Semiconductor, please visit our website at
www.onsemi.com

Please note: As part of the Fairchild Semiconductor integration, some of the Fairchild orderable part numbers will need to change in order to meet ON Semiconductor's system requirements. Since the ON Semiconductor product management systems do not have the ability to manage part nomenclature that utilizes an underscore (_), the underscore (_) in the Fairchild part numbers will be changed to a dash (-). This document may contain device numbers with an underscore (_). Please check the ON Semiconductor website to verify the updated device numbers. The most current and up-to-date ordering information can be found at www.onsemi.com. Please email any questions regarding the system integration to Fairchild_questions@onsemi.com.

ON Semiconductor and the ON Semiconductor logo are trademarks of Semiconductor Components Industries, LLC dba ON Semiconductor or its subsidiaries in the United States and/or other countries. ON Semiconductor owns the rights to a number of patents, trademarks, copyrights, trade secrets, and other intellectual property. A listing of ON Semiconductor's product/patent coverage may be accessed at www.onsemi.com/site/pdf/Patent-Marking.pdf. ON Semiconductor reserves the right to make changes without further notice to any products herein. ON Semiconductor makes no warranty, representation or guarantee regarding the suitability of its products for any particular purpose, nor does ON Semiconductor assume any liability arising out of the application or use of any product or circuit, and specifically disclaims any and all liability, including without limitation special, consequential or incidental damages. Buyer is responsible for its products and applications using ON Semiconductor products, including compliance with all laws, regulations and safety requirements or standards, regardless of any support or applications information provided by ON Semiconductor. "Typical" parameters which may be provided in ON Semiconductor data sheets and/or specifications can and do vary in different applications and actual performance may vary over time. All operating parameters, including "Typicals" must be validated for each customer application by customer's technical experts. ON Semiconductor does not convey any license under its patent rights nor the rights of others. ON Semiconductor products are not designed, intended, or authorized for use as a critical component in life support systems or any FDA Class 3 medical devices or medical devices with a same or similar classification in a foreign jurisdiction or any devices intended for implantation in the human body. Should Buyer purchase or use ON Semiconductor products for any such unintended or unauthorized application, Buyer shall indemnify and hold ON Semiconductor and its officers, employees, subsidiaries, affiliates, and distributors harmless against all claims, costs, damages, and expenses, and reasonable attorney fees arising out of, directly or indirectly, any claim of personal injury or death associated with such unintended or unauthorized use, even if such claim alleges that ON Semiconductor was negligent regarding the design or manufacture of the part. ON Semiconductor is an Equal Opportunity/Affirmative Action Employer. This literature is subject to all applicable copyright laws and is not for resale in any manner.



2014 年 11 月

FOD8320

高抗噪能力、2.5 A 输出电流、栅极驱动光电耦合器，采用 Optoplanar[®] 宽体 SOP 5 引脚

特性

- Fairchild 的 Optoplanar[®] 封装技术提供可靠的高电压隔离、超过 10 mm 的爬电和间隙距离以及 0.5 mm 的内部绝缘距离，同时还提供紧凑的尺寸
- 用于中等功率 IGBT/MOSFET 的 2.5 A 输出电流驱动能力
 - P 沟道 MOSFET 在输出级可实现接近供电轨的输出电压摆幅
- 35 kV/ μ s 最小共模抑制
- 宽电源电压范围：15 V 至 30 V
- 在整个工作温度范围内可快速开关：
 - 400 ns 最大传播延迟
 - 100 ns 最大脉宽失真度
- 具有滞回的欠压闭锁 (UVLO)
- 扩展工业温度范围：-40°C 至 100°C
- 安全和法规认证：
 - UL1577、5,000 V_{RMS} 1 分钟
 - DIN EN/IEC60747-5-5, 1,414 V 峰值工作绝缘电压

应用

- AC 和无刷 DC 电机驱动
- 工业变频器
- 不间断电源
- 感应加热
- 隔离 IGBT/ 功率 MOSFET 栅极驱动

相关资源

- [FOD3120, 高抗噪能力、2.5 A 输出电流、栅极驱动光电耦合器数据手册](#)
- www.fairchildsemi.com/products/opto/

描述

FOD8320 是一个 2.5 A 的输出电流栅极驱动光电耦合器，可驱动中等功率的 IGBT/MOSFET。它非常适用于快速开关驱动在电机控制逆变器应用以及高性能电源系统中使用的功率 IGBT 和 MOSFET。

FOD8320 采用 Fairchild 的 Optoplanar[®] 共面封装技术和优化的 IC 设计，实现了高绝缘电压和高抗噪能力。

它是由与具有高速驱动器的集成电路进行光耦合的铝砷化镓 (AlGaAs) 发光二极管 (LED) 组成，可实现推挽式 MOSFET 输出级。该器件包含在一个宽体 5 引脚小型塑料封装中。

功能示意图



图 1. 原理图



图 2. 封装外形

FOD8320 — 高抗噪能力、2.5 A 输出电流、栅极驱动光电耦合器，采用 Optoplanar[®] 宽体 SOP 5 引脚

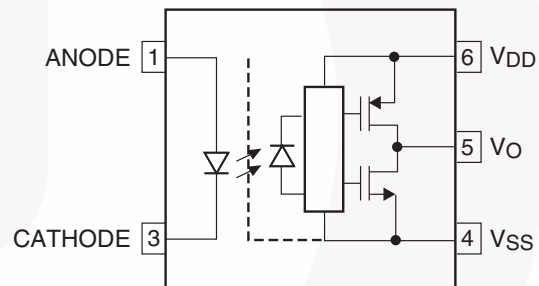
真值表

LED	$V_{DD} - V_{SS}$ “正向” (导通)	$V_{DD} - V_{SS}$ “正向” (关断)	V_O
关	0 V 至 30 V	0 V 至 30 V	低
导通	0 V 至 11.5 V	0 V 至 10 V	低
导通	11.5 V 至 14.5 V	10 V 至 13 V	转换
导通	14.5 V 至 30 V	13 V 至 30 V	高

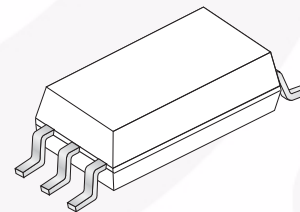
引脚配置



图 3. 引脚配置

引脚定义

引脚号	名称	描述
1	阳极	LED 阳极
3	阴极	LED 阴极
4	V_{SS}	负极电源电压
5	V_O	输出电压
6	V_{DD}	正向电源电压

安全性和绝缘标准

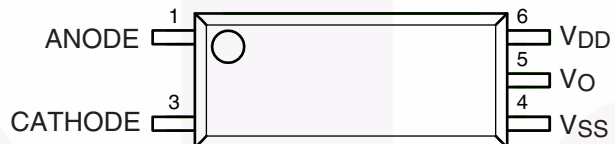
根据 DIN EN/IEC60747-5-5，此光电耦合器仅适用于安全极限数据之内的“安全电气绝缘”。通过保护性电路确保各项安全标准达标。

符号	参数	最小值	典型值	最大值	单位
	安装标准符合 DIN VDE 0110/1.89 表 1				
	用于额定市电电压 < 150 V _{RMS}		I-IV		
	用于额定市电电压 < 300 V _{RMS}		I-IV		
	用于额定市电电压 < 450 V _{RMS}		I-III		
	用于额定市电电压 < 600 V _{RMS}		I-III		
	气候分类		40/100/21		
	污染等级 (DIN VDE 0110/1.89)		2		
CTI	相比漏电起痕指数	175			
V _{PR}	输入至输出测试电压，方法 b，V _{IORM} × 1.875 = V _{PR} ，100% 生产测试，t _m = 1 s，局部放电 < 5 pC	2651			V _{peak}
	输入至输出测试电压，方法 a，V _{IORM} × 1.6 = V _{PR} ，类型和样品测试，t _m = 10 s，局部放电 < 5 pC	2262			V _{peak}
V _{IORM}	最大工作绝缘电压	1414			V _{peak}
V _{IOTM}	最高允许过电压	8000			V _{peak}
	外部爬电距离	10.0			mm
	外部绝缘间隙	10.0			mm
	绝缘厚度	0.5			mm
T _S	安全极限值 – 发生故障时允许的最大值				
	壳体温度	150			°C
I _{S,INPUT}	输入电流	200			mA
P _{S,OUTPUT}	输出功率	600			mW
R _{IO}	T _S , V _{IO} = 500 V 时的绝缘阻抗	10 ⁹			Ω

绝对最大额定值

应力超过绝对最大额定值，可能会损坏器件。在超出推荐的工作条件和应力的情况下，该器件可能无法正常工作，所以不建议让器件在这些条件下工作。此外，长期在高于推荐的工作条件下工作，会影响器件的可靠性。绝对最大额定值仅为额定应力值。除非另有说明， $T_A = 25^\circ\text{C}$ 。

符号	参数	数值	单位
T_{STG}	存储温度	-40 至 +125	$^\circ\text{C}$
T_{OPR}	工作温度	-40 至 +100	$^\circ\text{C}$
T_{J}	结温	-40 至 +125	$^\circ\text{C}$
T_{SOL}	引脚焊接温度 请参考第 15 页的回流焊温度曲线。	260, 10 s	$^\circ\text{C}$
$I_{\text{F(AVG)}}$	平均输入电流	25	mA
F	工作频率	50	kHz
V_{R}	反向输入电压	5.0	V
$I_{\text{O(PEAK)}}$	峰值输出电流 (1)	3.0	A
V_{DD}	电源电压	0 至 35	V
$V_{\text{O(PEAK)}}$	峰值输出电压	0 至 V_{DD}	V
$t_{\text{R(IN)}}, t_{\text{F(IN)}}$	输入信号上升和下降时间	500	ns
PD_{I}	输入功耗 (2)(4)	45	mW
PD_{O}	输出功耗 (3)(4)	500	mW

注意：

1. 最大脉宽 = 10 μs ，最大占空比 = 0.2%。
2. 在整个工作温度范围内无需降额。
3. 线性降额，从额定值 5.2 mW/ $^\circ\text{C}$ ， 25°C 开始。
4. 不建议在这些条件下运行。如果所经受的条件超出额定值，器件可能出现永久损害。

推荐工作条件

推荐的操作条件表明了器件的真实工作条件。指定推荐的工作条件，以确保器件的最佳性能达到数据表中的规格。飞兆不建议超出额定或依照绝对最大额定值进行设计。

符号	参数	最小值	最大值	单位
T_{A}	工作环境温度	-40	100	$^\circ\text{C}$
$V_{\text{DD}} - V_{\text{SS}}$	电源电压	16	30	V
$I_{\text{F(ON)}}$	输入电流 (ON)	7	16	mA
$V_{\text{F(OFF)}}$	输入电压 (OFF)	0	0.8	V

绝缘特性

应用于所有推荐的条件，典型值测量为 $T_A = 25^\circ\text{C}$ 。

符号	参数	工作条件	最小值	典型值	最大值	单位
V_{ISO}	输入输出绝缘电压	$T_A = 25^\circ\text{C}$, R.H. < 50%, $t = 60\text{ s}$, $I_{I-O} \leq 20\ \mu\text{A}$, 50 Hz ⁽⁵⁾⁽⁶⁾	5,000			V_{RMS}
R_{ISO}	绝缘电阻	$V_{I-O} = 500\text{ V}^{(5)}$		10^{11}		Ω
C_{ISO}	绝缘电容	$V_{I-O} = 0\text{ V}$, Frequency = 1.0 MHz ⁽⁶⁾		1		pF

注意:

- 器件属于双端器件：引脚 1 和 3 短接在一起，引脚 4、5 和 6 短接在一起。
- 5,000 VAC_{RMS} 持续 1 分钟相当于 6,000 VAC_{RMS} 持续 1 秒钟。

电气特性

应用于所有建议条件，典型值在 $V_{DD} = 30\text{ V}$ ， $V_{SS} = \text{接地}$ ， $T_A = 25^\circ\text{C}$ 时测得（除非另有说明）。

符号	参数	工作条件	最小值	典型值	最大值	单位	图
V_F	输入正向电压	$I_F = 10\text{ mA}$	1.1	1.5	1.8	V	19
$\Delta(V_F / T_A)$	正向电压温度系数		-1.8			mV/°C	
BV_R	反向击穿输入电压	$I_R = 10\ \mu\text{A}$	5			V	
C_{IN}	输入电容	$f = 1\text{ MHz}$, $V_F = 0\text{ V}$		60		pF	
I_{OH}	高电平输出电流 ⁽¹⁾	$V_{OH} = V_{DD} - 3\text{ V}$	1.0	2.0	2.5	A	4, 6
		$V_{OH} = V_{DD} - 6\text{ V}$	2.0		2.5	A	4, 6, 22
I_{OL}	低电平输出电流 ⁽¹⁾	$V_{OL} = V_{SS} + 3\text{ V}$	1.0	2.0	2.5	A	7, 9
		$V_{OL} = V_{SS} + 6\text{ V}$	2.0		2.5	A	7, 9, 21
V_{OH}	高电平输出电压 ⁽⁷⁾⁽⁸⁾	$I_F = 10\text{ mA}$, $I_O = -2.5\text{ A}$	$V_{DD} - 6.25$	$V_{DD} - 2.5$		V	4
		$I_F = 10\text{ mA}$, $I_O = -100\text{ mA}$	$V_{DD} - 0.5$	$V_{DD} - 0.1$			4, 5, 23
V_{OL}	低电平输出电压 ⁽⁷⁾⁽⁸⁾	$I_F = 10\text{ mA}$, $I_O = 2.5\text{ A}$		$V_{SS} + 2.5$	$V_{SS} + 6.25$	V	7
		$I_F = 0\text{ mA}$, $I_O = 100\text{ mA}$		$V_{SS} + 0.1$	$V_{SS} + 0.5$		8, 24
I_{DDH}	高电平电源电流	V_O 开路, $I_F = 7$ 至 16 mA		2.9	3.8	mA	10, 11, 25
I_{DDL}	低电平电源电流	V_O 开路, $V_F = 0$ 至 0.8 mA		2.8	3.8	mA	10, 11, 26
I_{FLH}	阈值输入电流 低电平至高电平	$I_O = 0\text{ mA}$, $V_O > 5\text{ V}$		2.4	5.0	mA	12, 18, 27
V_{FHL}	阈值输入电压 高至低	$I_O = 0\text{ mA}$, $V_O < 5\text{ V}$	0.8			V	28
V_{UVLO+}	欠压闭锁阈值	$I_F = 10\text{ mA}$, $V_O > 5\text{ V}$	11.5	12.7	14.5	V	20, 29
V_{UVLO-}		$I_F = 10\text{ mA}$, $V_O < 5\text{ V}$	10.0	11.2	13.0	V	20, 29
$UVLO_{HYS}$	欠压闭锁阈值滞后			1.5		V	

注意:

- 在此测试中， V_{OH} 在 dc 负载电流为 100 mA 时测得。驱动容性负载时， V_{OH} 将随着 I_{OH} 接近 0 A 而接近 V_{DD} 。
- 最大脉宽 = 1 ms，最大占空比 = 20%。

开关特性

应用于所有建议条件，典型值在 $V_{DD} = 30\text{ V}$ ， $V_{SS} = \text{接地}$ ， $T_A = 25^\circ\text{C}$ 时测得（除非另有说明）。

符号	参数	工作条件	最小值	典型值	最大值	单位	图
t_{PHL}	逻辑低输出的传播延迟时间 ⁽⁹⁾	$I_F = 7\text{ mA 至 } 16\text{ mA}$ ， $R_g = 10\ \Omega$ ， $C_g = 10\text{ nF}$ ， $f = 10\text{ kHz}$ ， 占空比 = 50%	150	285	400	ns	13, 14, 15, 16, 17, 30
t_{PLH}	逻辑高输出的传播延迟时 ⁽¹⁰⁾		150	260	400	ns	13, 14, 15, 16, 17, 30
PWD	脉宽失真度 ⁽¹¹⁾ $ t_{PHL} - t_{PLH} $		25	100	ns		
PDD (偏斜)	任意两个器件之间的传播延迟差 ⁽¹²⁾		-250	250			
t_R	输出上升时间 (10% 至 90%)		60		ns	30	
t_F	输出下降时间 (90% 至 10%)		60		ns	30	
$t_{ULVO\ ON}$	ULVO 导通延迟		$I_F = 10\text{ mA}$ ， $V_O > 5\text{ V}$		0.8		μs
$t_{ULVO\ OFF}$	ULVO 关断延迟	$I_F = 10\text{ mA}$ ， $V_O < 5\text{ V}$		0.4		μs	
$ CM_H $	输出高时的共模瞬态抑制性	$T_A = 25^\circ\text{C}$ ， $V_{DD} = 30\text{ V}$ ， $I_F = 7\text{ mA 至 } 16\text{ mA}$ ， $V_{CM} = 2000\text{ V}^{(13)}$	35	50		$\text{kV}/\mu\text{s}$	31
$ CM_L $	输出低时的共模瞬态抑制性	$T_A = 25^\circ\text{C}$ ， $V_{DD} = 30\text{ V}$ ， $V_F = 0\text{ V}$ ， $V_{CM} = 2000\text{ V}^{(14)}$	35	50		$\text{kV}/\mu\text{s}$	31

注意：

9. 传播延迟 t_{PHL} 的测量是从输入脉冲下降沿的 50% 电平至 V_O 信号下降沿的 50% 电平。
10. 传播延迟 t_{PLH} 的测量是从输入脉冲上升沿的 50% 电平至 V_O 信号上升沿的 50% 电平。
11. 在任何给定器件上，PWD 被定义为 $|t_{PHL} - t_{PLH}|$ 。
12. 在相同的工作条件下，负载相同的任意两个 FOD8320 器件之间 t_{PHL} 和 t_{PLH} 之差。
13. 输出高电平状态下的共模瞬态抑制性是共模脉冲信号后沿上的最大容许负 dV_{cm}/dt ， V_{CM} ，从而确保输出将保持高电平状态（即 $V_O > 15.0\text{ V}$ ）。
14. 输出低电平状态下的共模瞬态抑制性是共模脉冲信号前沿上的最大容许正 dV_{cm}/dt ， V_{CM} ，从而确保输出将保持低电平状态（即 $V_O < 1.0\text{ V}$ ）。

典型性能特征

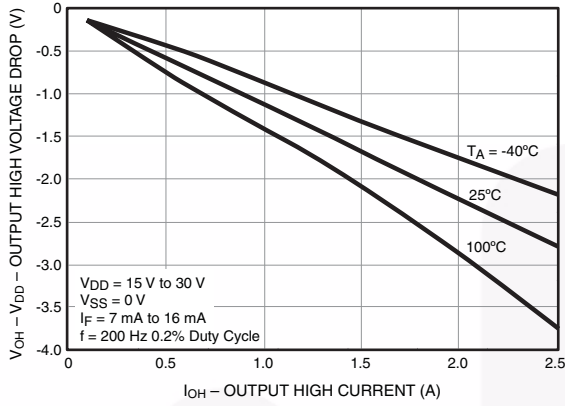

Figure 4. Output High Voltage Drop vs. Output High Current

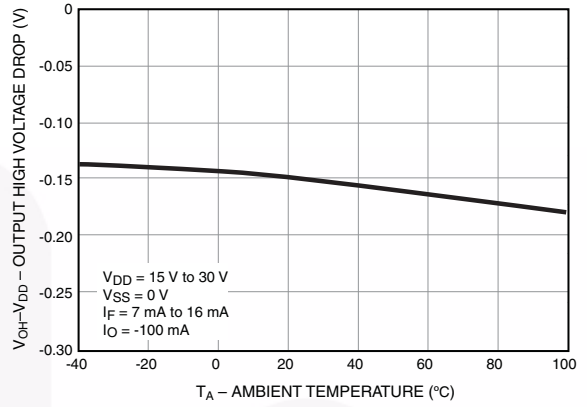

Figure 5. Output High Voltage Drop vs. Ambient Temperature

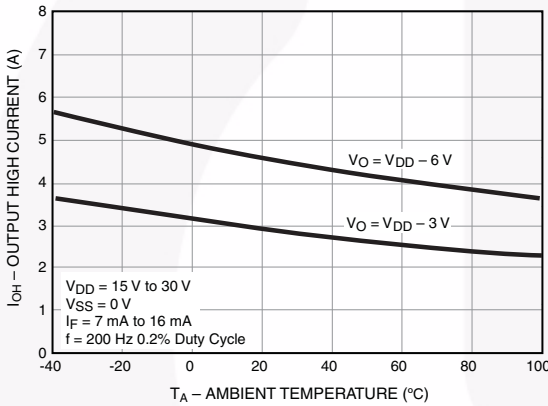

Figure 6. Output High Current vs. Ambient Temperature

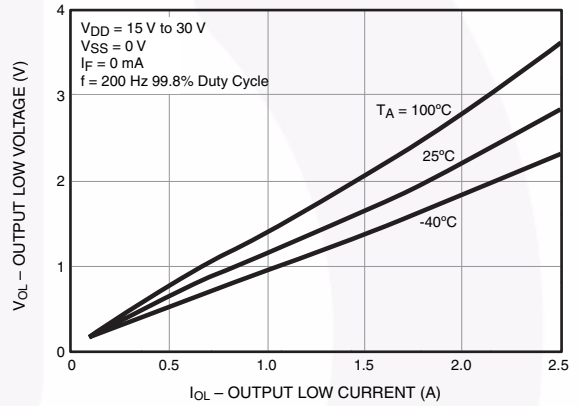

Figure 7. Output Low Voltage vs. Output Low Current

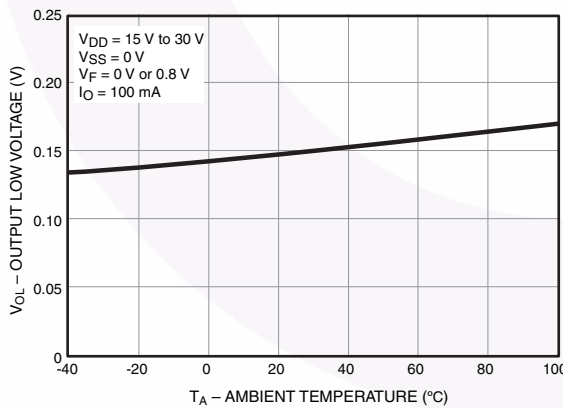

Figure 8. Output Low Voltage vs. Ambient Temperature

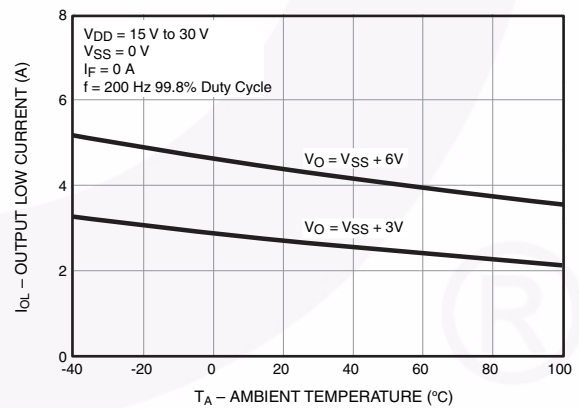

Figure 9. Output Low Current vs. Ambient Temperature

典型性能特征 (续)

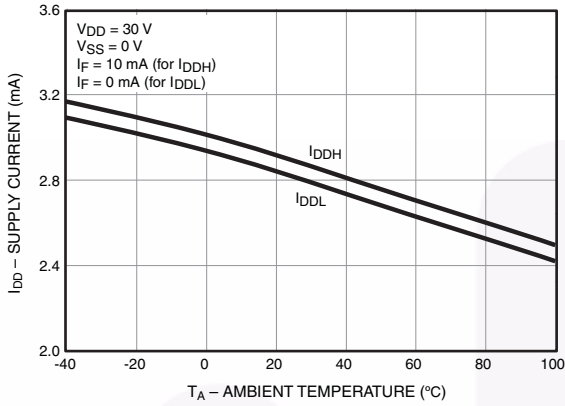

Figure 10. Supply Current vs. Ambient Temperature

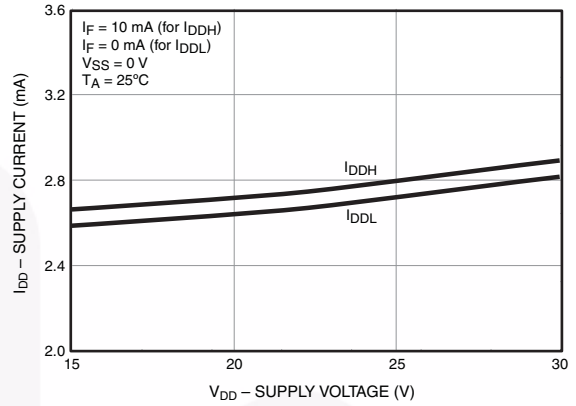

Figure 11. Supply Current vs. Supply Voltage

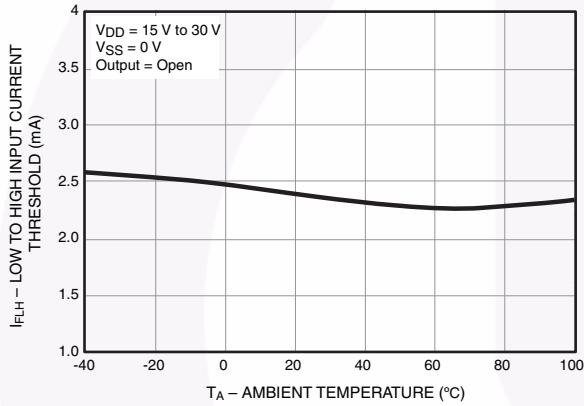

Figure 12. Low to High Input Current Threshold vs. Ambient Temperature

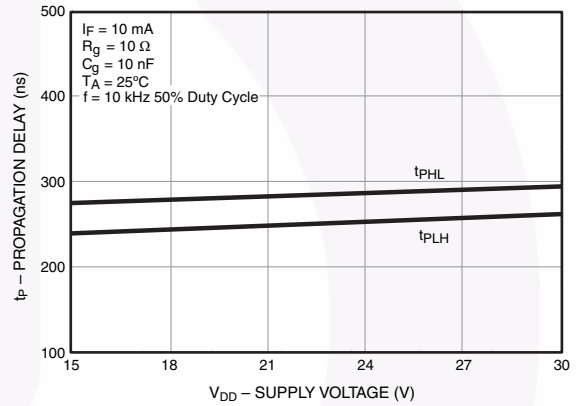

Figure 13. Propagation Delay vs. Supply Voltage

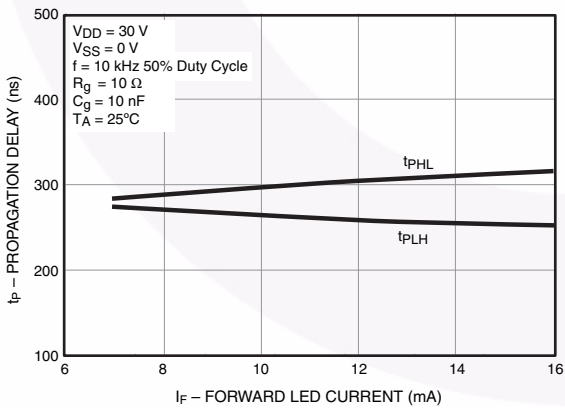

Figure 14. Propagation Delay vs. LED Forward Current

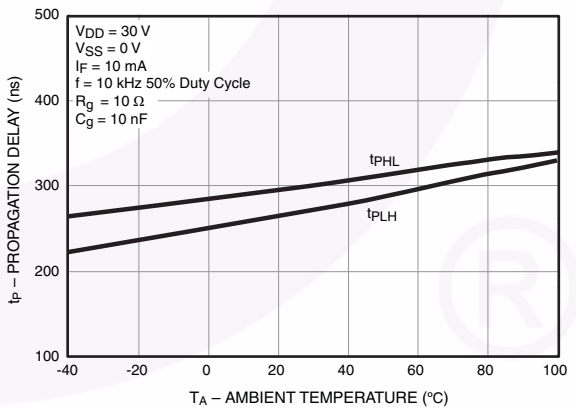

Figure 15. Propagation Delay vs. Ambient Temperature

典型性能特征 (续)

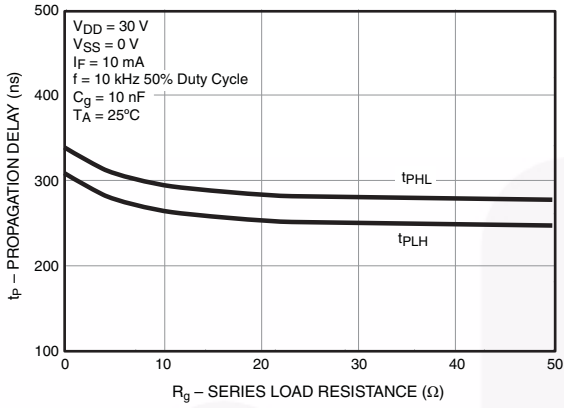

Figure 16. Propagation Delay vs. Series Load Resistance

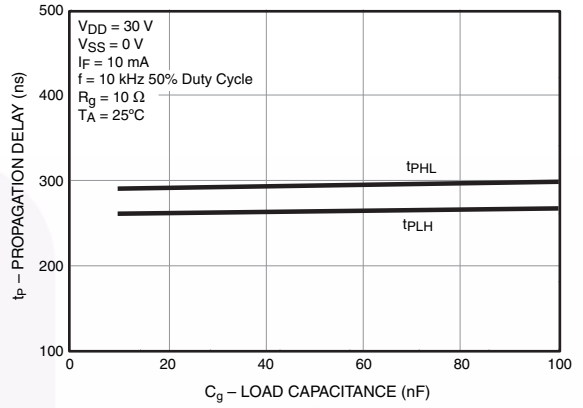

Figure 17. Propagation Delay vs. Load Capacitance

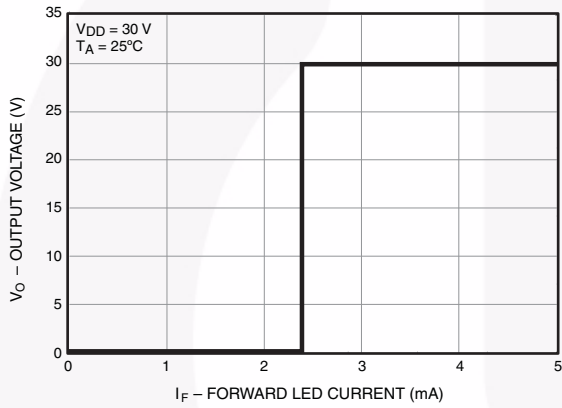

Figure 18. Transfer Characteristics

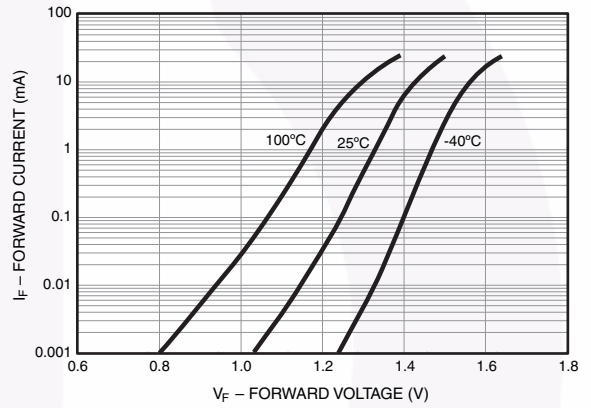

Figure 19. Input Forward Current vs. Forward Voltage

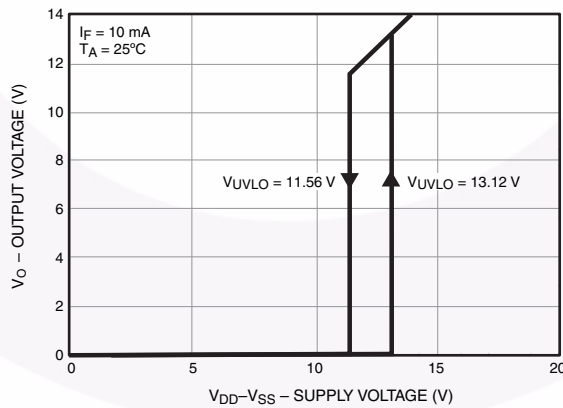

Figure 20. Under Voltage Lockout

测试电路



图 21. I_{OL} 测试电路



图 22. I_{OH} 测试电路

测试电路 (续)

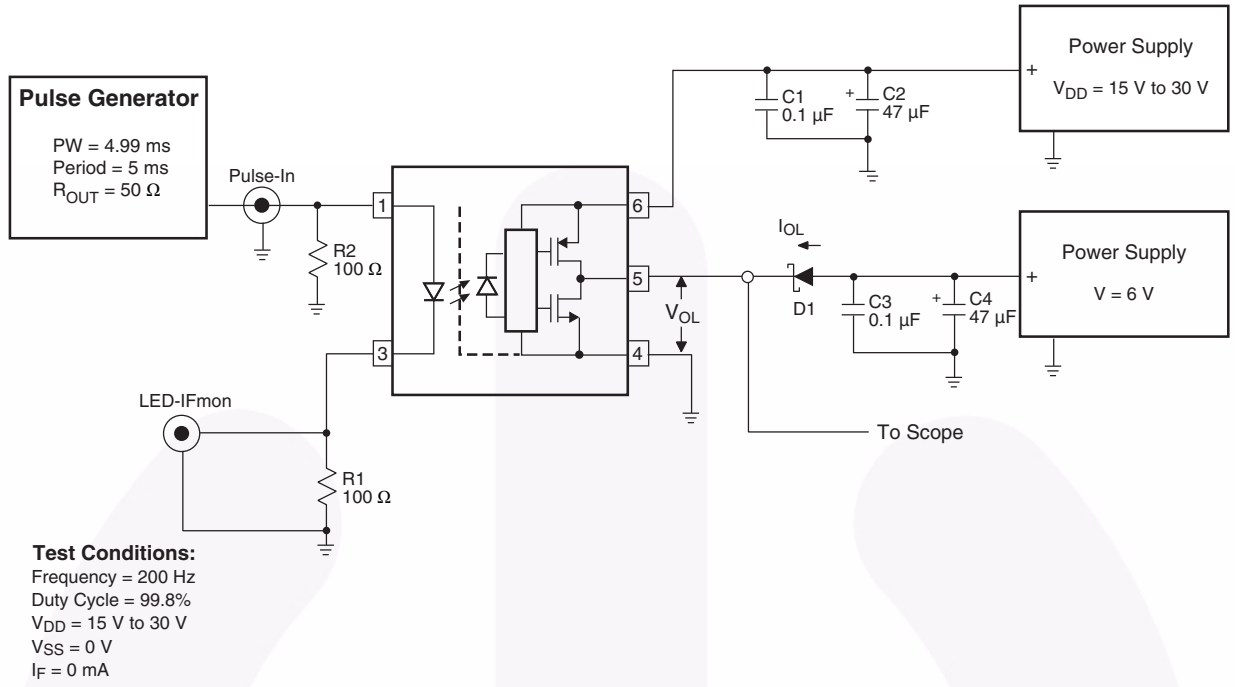

图 23. V_{OH} 测试电路

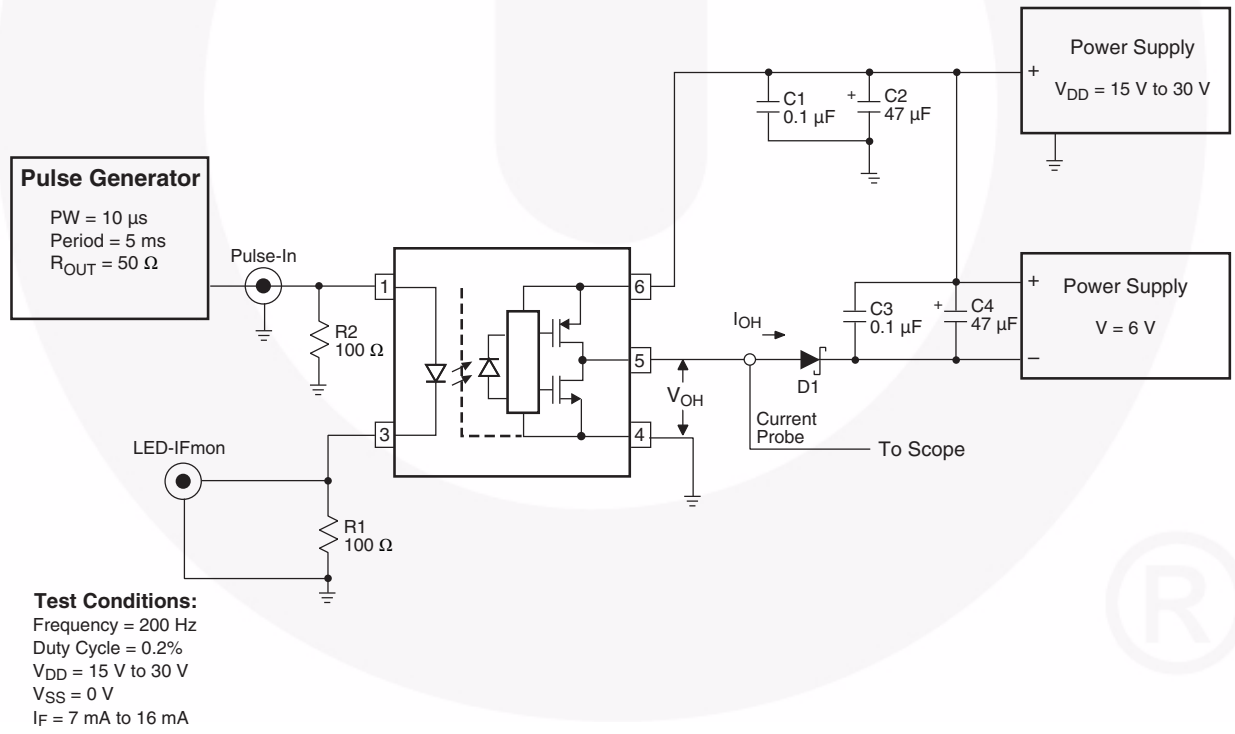

图 24. V_{OL} 测试电路

测试电路 (续)

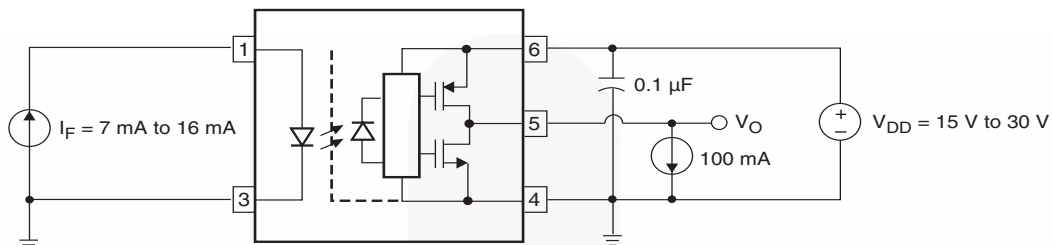

图 25. I_{DDH} 测试电路

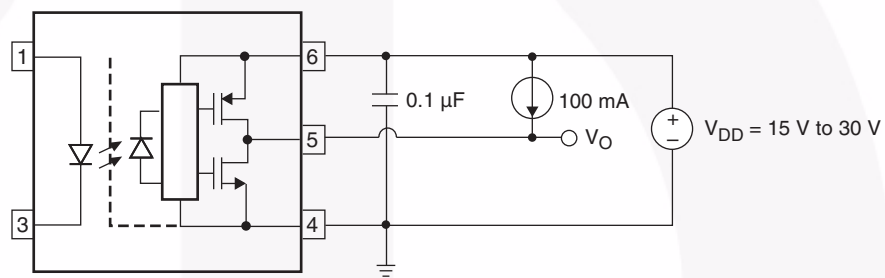

图 26. I_{DDL} 测试电路

测试电路 (续)

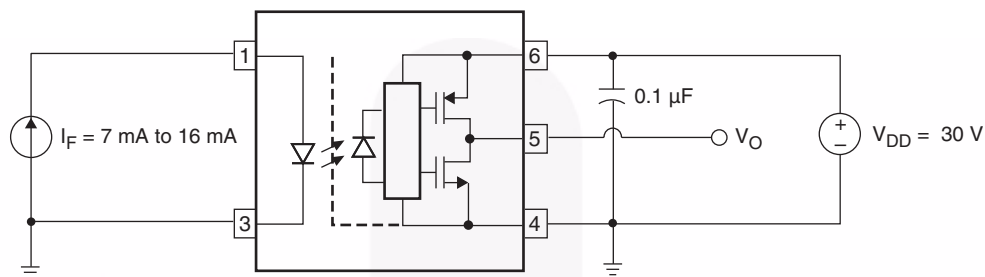

图 27. I_{FLH} 测试电路

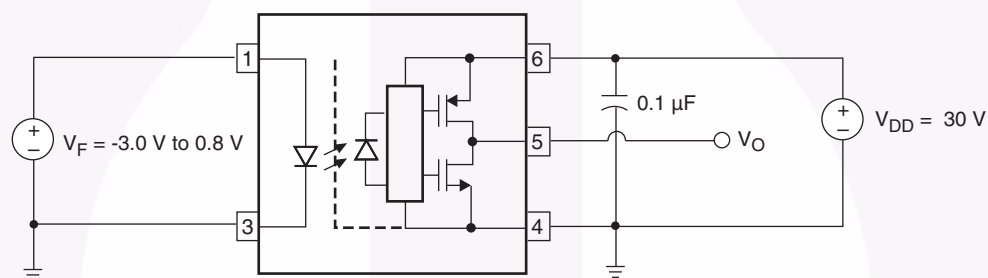

图 28. I_{FHL} 测试电路

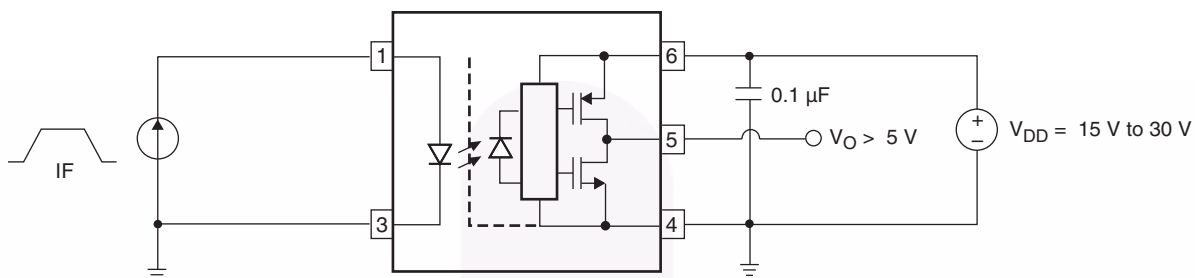

图 29. UVLO 测试电路

测试电路 (续)

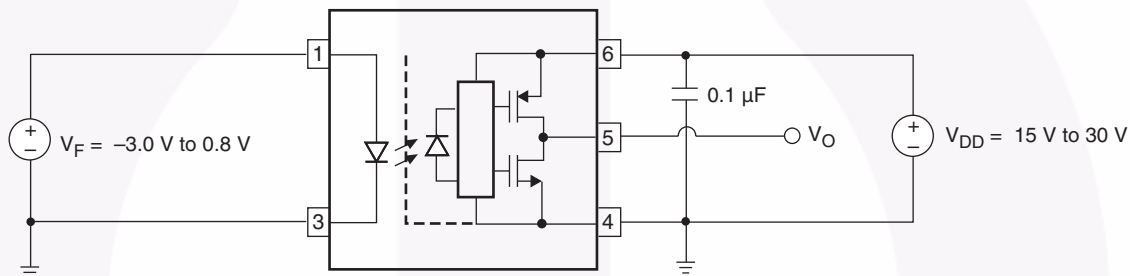

图 30. t_{PHL}、t_{PLH}、t_R 和 t_F 测试电路和波形

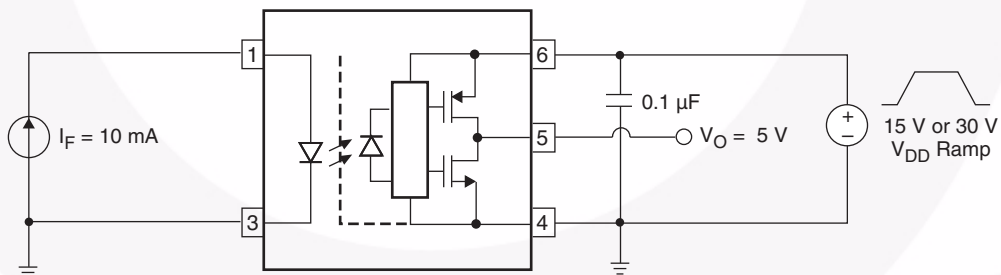

图 31. CMR 测试电路与波形

回流焊数据

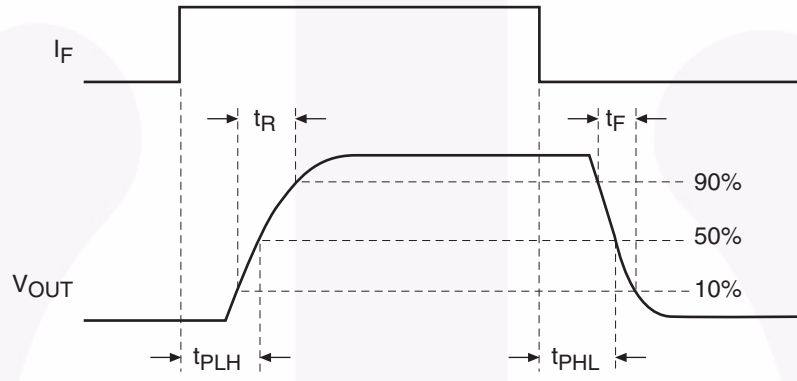
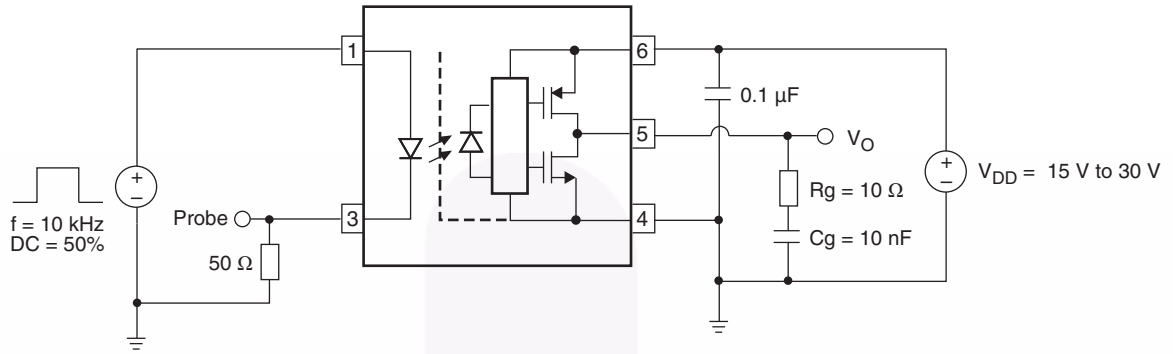

特征	无铅装配数据
最低温度 (T_{smin})	150°C
最高温度 (T_{smax})	200°C
时间 (t_s) (T_{smin} 至 T_{smax})	60 s 至 120 s
斜升率 (t_L 至 t_p)	3°C/ 秒 (最大值)
液态温度 (T_L)	217°C
保持在 (t_L) 以上的时间 (t_L)	60 s 至 150 s
体封装温度峰值	260°C +0°C / -5°C
时间 (t_p) 在 260°C 中的 5°C 内	30 s
斜降率 (T_p 至 T_L)	6°C/s (最大值)
25°C 至峰值温度的时间	8 分钟 (最大值)

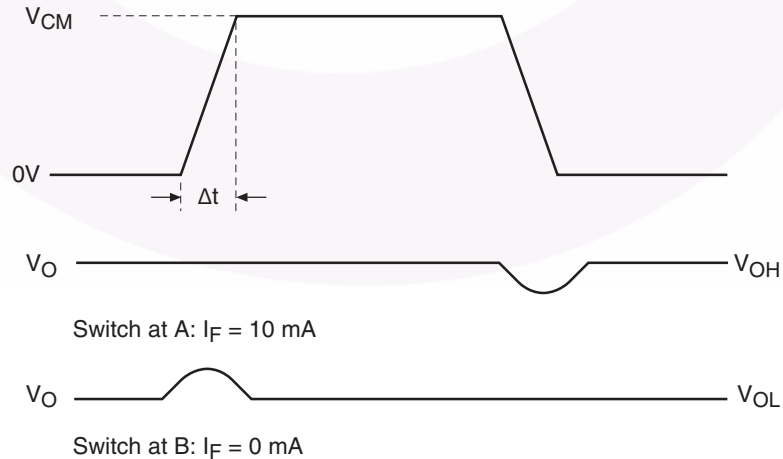
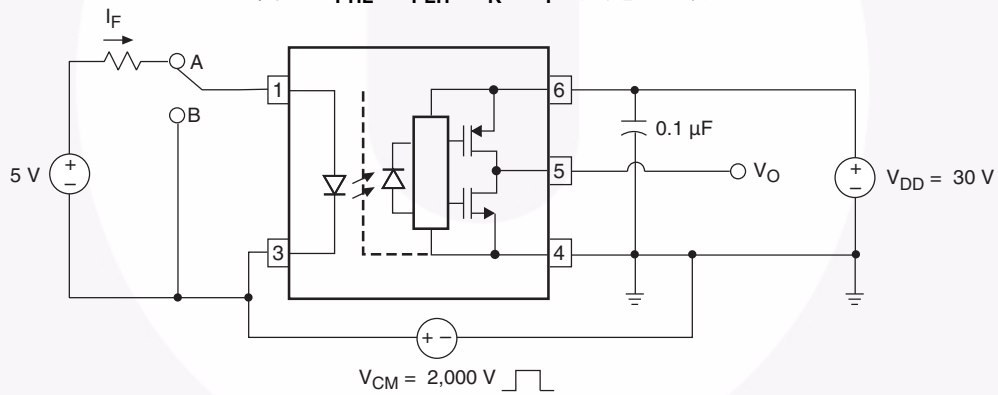
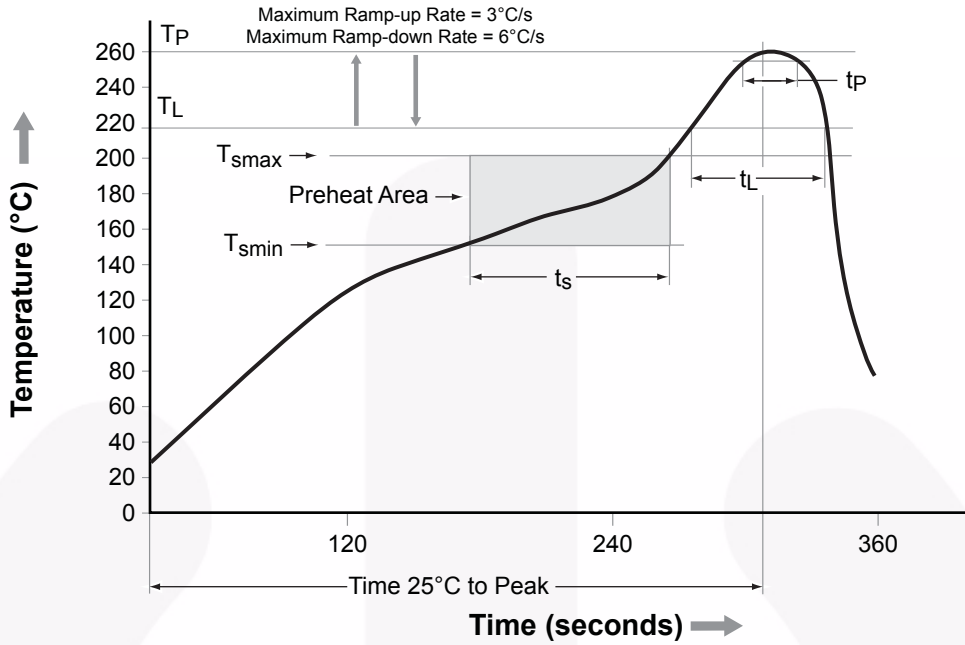
图 32. 回流焊数据

订购信息

器件编号	封装	包装方法
FOD8320	宽体 SOP 5 引脚	卷管（每卷管 100 装）
FOD8320R2	宽体 SOP 5 引脚	卷带和卷盘（每卷 1000 装）
FOD8320V	宽体 SOP 5 引脚，DIN EN/IEC60747-5-5 选项	卷管（每卷管 100 装）
FOD8320R2V	宽体 SOP 5 引脚，DIN EN/IEC60747-5-5 选项	卷带和卷盘（每卷 1000 装）

 根据 JEDEC: J-STD-020B 标准, J-STD-020B 标准。

标识信息

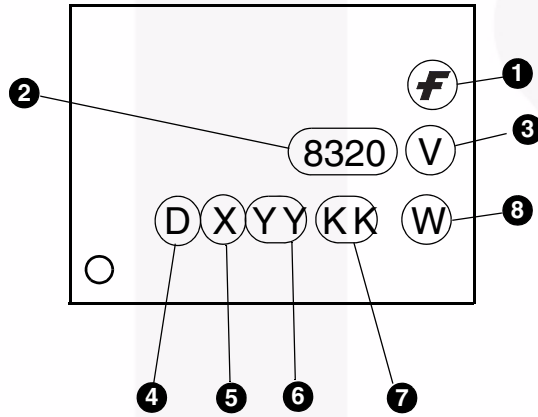

定义

1	Fairchild 徽标
2	器件号，例如，“8320”代表 FOD8320
3	DIN EN/IEC60747-5-5 选项（只有组件订购附带此选项时出现）
4	工厂代码，例如，“D”
5	上一个数字年份代码，例如，“C”代表 2012
6	两位数工作周数，从“01”到“53”
7	批量可追溯性代码
8	封装装配代码，W

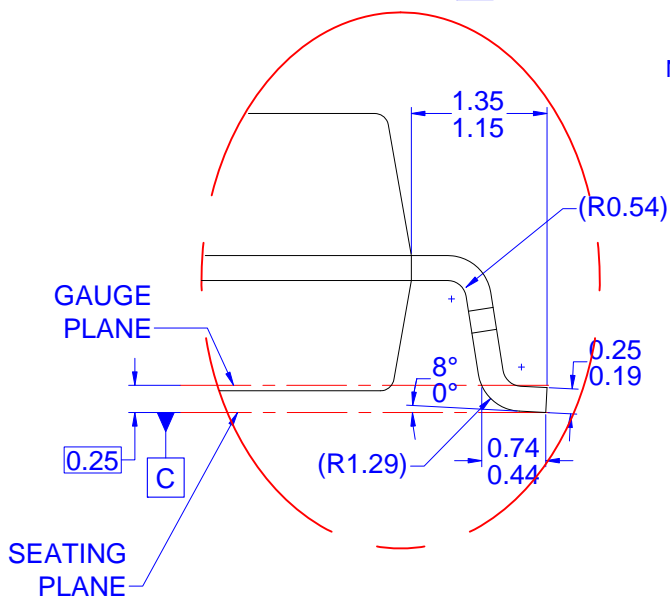
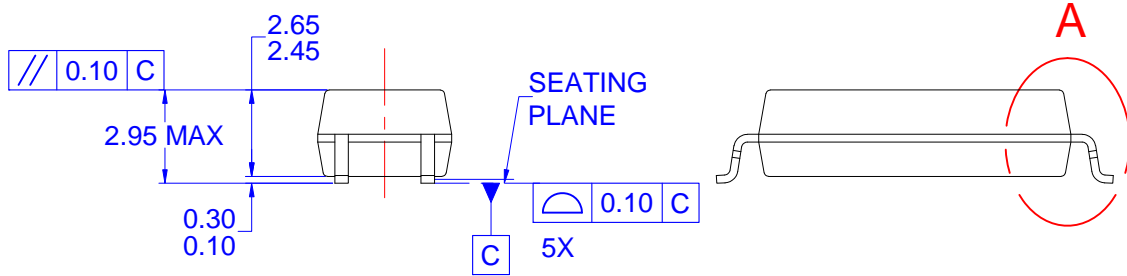
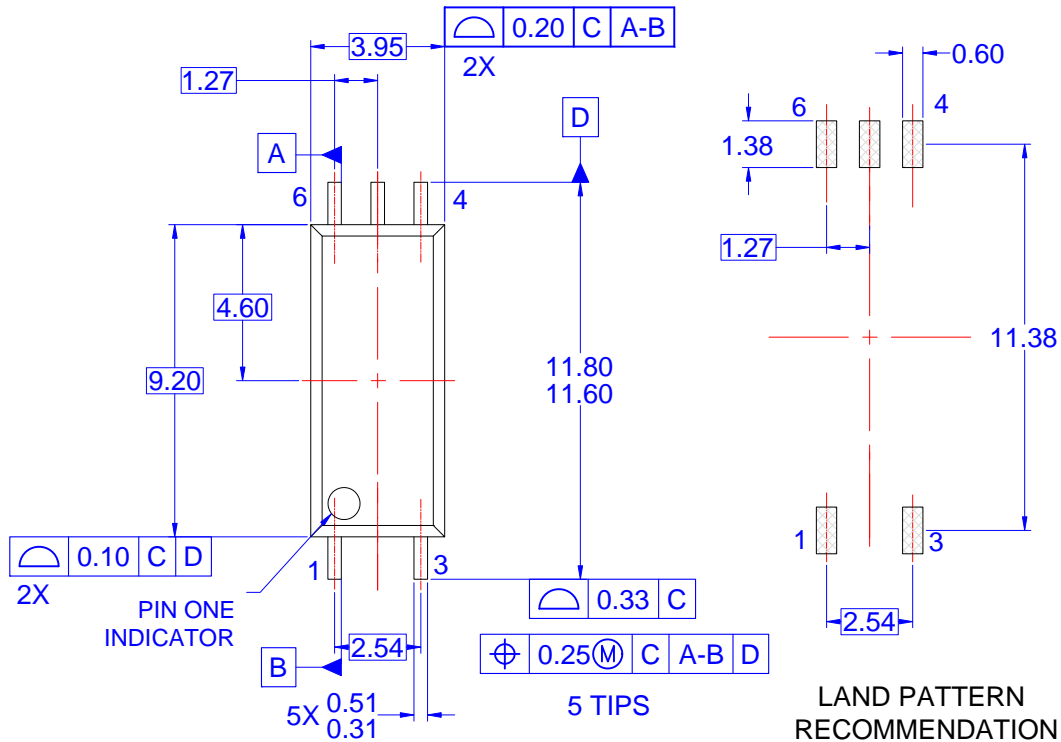

DETAIL A
SCALE: 3.2:1

NOTES: UNLESS OTHERWISE SPECIFIED

- A) THIS PACKAGE DOES NOT CONFORM TO ANY STANDARD.
- B) ALL DIMENSIONS ARE IN MILLIMETERS.
- C) DIMENSIONS ARE EXCLUSIVE OF BURRS, MOLD FLASH AND TIE BAR PROTRUSIONS
- D) DRAWING CONFORMS TO ASME Y14.5M-1994
- E) DRAWING FILE NAME: MKT-M05AREV3

ON Semiconductor and  are trademarks of Semiconductor Components Industries, LLC dba ON Semiconductor or its subsidiaries in the United States and/or other countries. ON Semiconductor owns the rights to a number of patents, trademarks, copyrights, trade secrets, and other intellectual property. A listing of ON Semiconductor's product/patent coverage may be accessed at www.onsemi.com/site/pdf/Patent-Marking.pdf. ON Semiconductor reserves the right to make changes without further notice to any products herein. ON Semiconductor makes no warranty, representation or guarantee regarding the suitability of its products for any particular purpose, nor does ON Semiconductor assume any liability arising out of the application or use of any product or circuit, and specifically disclaims any and all liability, including without limitation special, consequential or incidental damages. Buyer is responsible for its products and applications using ON Semiconductor products, including compliance with all laws, regulations and safety requirements or standards, regardless of any support or applications information provided by ON Semiconductor. "Typical" parameters which may be provided in ON Semiconductor data sheets and/or specifications can and do vary in different applications and actual performance may vary over time. All operating parameters, including "Typicals" must be validated for each customer application by customer's technical experts. ON Semiconductor does not convey any license under its patent rights nor the rights of others. ON Semiconductor products are not designed, intended, or authorized for use as a critical component in life support systems or any FDA Class 3 medical devices or medical devices with a same or similar classification in a foreign jurisdiction or any devices intended for implantation in the human body. Should Buyer purchase or use ON Semiconductor products for any such unintended or unauthorized application, Buyer shall indemnify and hold ON Semiconductor and its officers, employees, subsidiaries, affiliates, and distributors harmless against all claims, costs, damages, and expenses, and reasonable attorney fees arising out of, directly or indirectly, any claim of personal injury or death associated with such unintended or unauthorized use, even if such claim alleges that ON Semiconductor was negligent regarding the design or manufacture of the part. ON Semiconductor is an Equal Opportunity/Affirmative Action Employer. This literature is subject to all applicable copyright laws and is not for resale in any manner.

PUBLICATION ORDERING INFORMATION

LITERATURE FULFILLMENT:

Literature Distribution Center for ON Semiconductor
19521 E. 32nd Pkwy, Aurora, Colorado 80011 USA
Phone: 303-675-2175 or 800-344-3860 Toll Free USA/Canada
Fax: 303-675-2176 or 800-344-3867 Toll Free USA/Canada
Email: orderlit@onsemi.com

N. American Technical Support: 800-282-9855 Toll Free
USA/Canada
Europe, Middle East and Africa Technical Support:
Phone: 421 33 790 2910
Japan Customer Focus Center
Phone: 81-3-5817-1050

ON Semiconductor Website: www.onsemi.com
Order Literature: <http://www.onsemi.com/orderlit>
For additional information, please contact your local
Sales Representative