

LMV931, LMV932

Operational Amplifier, Rail-to-Rail, Low Voltage, Single and Dual

The LMV931 Single and LMV932 Dual are CMOS low-voltage operational amplifiers which can operate on single-sided power supplies (1.8 V to 5.0 V) with rail-to-rail input and output swing. Both devices come in small state-of-the-art packages and require very low quiescent current making them ideal for battery-operated, portable applications such as notebook computers and hand-held instruments. Rail-to-Rail operation provides improved signal-to-noise performance plus the small packages allow for closer placement to signal sources thereby reducing noise pickup.

The single LMV931 is offered in space saving SC70-5 package. The dual LMV932 is in either a Micro8 or SOIC package. These small packages are very beneficial for crowded PCB's.

Features

- Performance Specified on Single-Sided Power Supply: 1.8 V, 2.7 V, and 5 V
- Small Packages:
 - LMV931 in a SC-70
 - LMV932 in a Micro8 or SOIC-8
- No Output Crossover Distortion
- Extended Industrial Temperature Range: -40°C to $+125^{\circ}\text{C}$
- Low Quiescent Current 210 μA , Max Per Channel
- No Output Phase-Reversal from Overdriven Input
- These are Pb-Free Devices

Typical Applications

- Notebook Computers, Portable Battery-Operated Instruments, PDA's
- Active Filters, Low-Side Current Monitoring

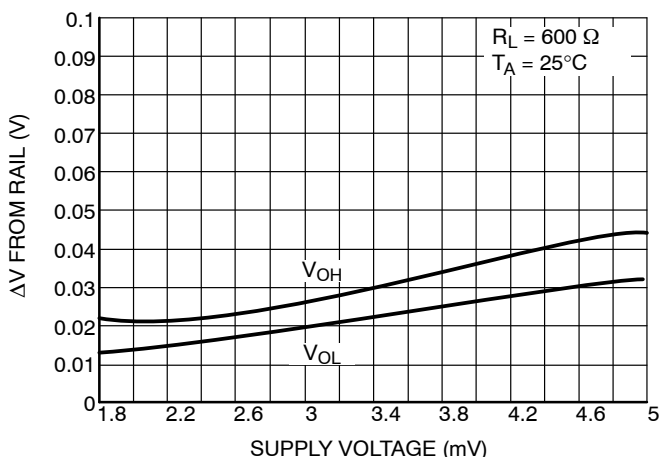

Figure 1. Output Voltage Swing vs. Supply Voltage



ON Semiconductor®

<http://onsemi.com>

MARKING DIAGRAMS

LMV931 (Single)

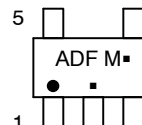
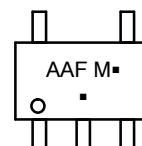

M = Date Code
▪ = Pb-Free Package

(*Note: Microdot may be in either location)

LMV932 (Dual)

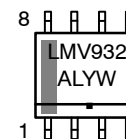
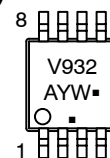

A = Assembly Location
Y = Year
L = Wafer Lot
W = Work Week
▪ = Pb-Free Package

(*Note: Microdot may be in either location)

ORDERING INFORMATION

See detailed ordering and shipping information in the package dimensions section on page 14 of this data sheet.

LMV931, LMV932

PIN CONNECTIONS

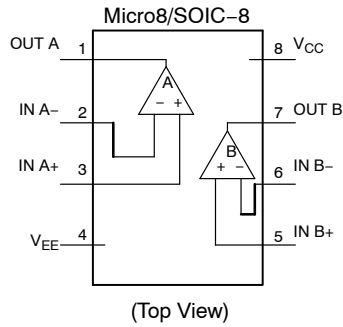
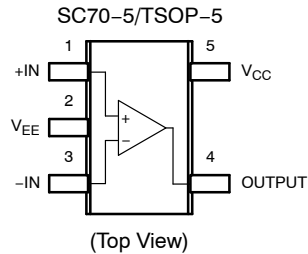

MAXIMUM RATINGS

Symbol	Rating	Value	Unit
V_S	Supply Voltage (Operating Range $V_S = 1.8\text{ V to }5.5\text{ V}$)	5.5	V
V_{IDR}	Input Differential Voltage	\pm Supply Voltage	V
V_{ICR}	Input Common Mode Voltage Range	$-0.5\text{ to }(V_{CC}) + 0.5$	V
	Maximum Input Current	10	mA
t_{SO}	Output Short Circuit (Note 1)	Continuous	
T_J	Maximum Junction Temperature (Operating Range $-40^\circ\text{C to }85^\circ\text{C}$)	150	$^\circ\text{C}$
θ_{JA}	Thermal Resistance:		$^\circ\text{C/W}$
	SC-70	280	
	TSOP-5	333	
	Micro8	238	
T_{stg}	Storage Temperature	$-65\text{ to }150$	$^\circ\text{C}$
	Mounting Temperature (Infrared or Convection $\leq 30\text{ sec}$)	260	$^\circ\text{C}$

Stresses exceeding Maximum Ratings may damage the device. Maximum Ratings are stress ratings only. Functional operation above the Recommended Operating Conditions is not implied. Extended exposure to stresses above the Recommended Operating Conditions may affect device reliability.

ESD data available upon request.

1. Continuous short-circuit operation to ground at elevated ambient temperature can result in exceeding the maximum allowed junction temperature of 150°C . Output currents in excess of 45 mA over long term may adversely affect reliability. Shorting output to either V_{CC} or V_{EE} will adversely affect reliability.

LMV931, LMV932

1.8 V DC ELECTRICAL CHARACTERISTICS (Note 2) Unless otherwise noted, all min/max limits are guaranteed for $T_A = 25^\circ\text{C}$, $V_S = 1.8\text{ V}$, $V_{CM} = V_S/2$, $V_O = V_S/2$ and $R_L > 1\text{ M}\Omega$. Typical specifications represent the most likely parametric norm.

Parameter	Symbol	Condition	Min	Typ	Max	Unit
Input Offset Voltage	V_{IO}	LMV931 (Single) (-40°C to $+125^\circ\text{C}$)		1	6	mV
		LMV932 (Dual) (-40°C to $+125^\circ\text{C}$)		1	7.5	
Input Offset Voltage Average Drift	TCV_{IO}			5.5		$\mu\text{V}/^\circ\text{C}$
Input Bias Current	I_B	-40°C to $+125^\circ\text{C}$		< 1		nA
Input Offset Current	I_{IO}	-40°C to $+125^\circ\text{C}$		< 1		nA
Supply Current (per Channel)	I_{CC}	In Active Mode		75	185	μA
		-40°C to $+125^\circ\text{C}$			205	
Common Mode Rejection Ratio	CMRR	$0\text{ V} \leq V_{CM} \leq 0.6\text{ V}$, $1.4\text{ V} \leq V_{CM} \leq 1.8\text{ V}$	50	70		dB
		-40°C to $+125^\circ\text{C}$	50			
		$-0.2\text{ V} \leq V_{CM} \leq 0\text{ V}$, $1.8\text{ V} \leq V_{CM} \leq 2\text{ V}$	50	70		
Power Supply Rejection Ratio	PSRR	$1.8\text{ V} \leq V^+ \leq 5\text{ V}$, $V_{CM} = 0.5\text{ V}$	50	70		dB
		-40°C to $+125^\circ\text{C}$	50			
Input Common-Mode Voltage Range	VCM	For CMRR $\geq 50\text{ dB}$ and $T_A = 25^\circ\text{C}$	$V_{EE} - 0.2$	-0.2 to 2.1	$V_{CC} + 0.2$	V
		For CMRR $\geq 50\text{ dB}$ and $T_A = -40^\circ\text{C}$ to $+85^\circ\text{C}$	V_{EE}		V_{CC}	
		For CMRR $\geq 50\text{ dB}$ and $T_A = -40^\circ\text{C}$ to $+125^\circ\text{C}$	$V_{EE} + 0.2$		$V_{CC} - 0.2$	
Large Signal Voltage Gain LMV931 (Single)	A_V	$R_L = 600\ \Omega$ to 0.9 V , $V_O = 0.2\text{ V}$ to 1.6 V , $V_{CM} = 0.5\text{ V}$	77	101		dB
		-40°C to $+125^\circ\text{C}$	73			
		$R_L = 2\text{ k}\Omega$ to 0.9 V , $V_O = 0.2\text{ V}$ to 1.6 V , $V_{CM} = 0.5\text{ V}$	80	105		
		-40°C to $+125^\circ\text{C}$	75			
Large Signal Voltage Gain LMV932 (Dual)	A_V	$R_L = 600\ \Omega$ to 0.9 V , $V_O = 0.2\text{ V}$ to 1.6 V , $V_{CM} = 0.5\text{ V}$	75	90		dB
		-40°C to $+125^\circ\text{C}$	72			
		$R_L = 2\text{ k}\Omega$ to 0.9 V , $V_O = 0.2\text{ V}$ to 1.6 V , $V_{CM} = 0.5\text{ V}$	78	100		
		-40°C to $+125^\circ\text{C}$	75			
Output Swing	V_{OH}	$R_L = 600\ \Omega$ to 0.9 V , $V_{IN} = \pm 100\text{ mV}$	1.65	1.72		V
		-40°C to $+125^\circ\text{C}$	1.63			
	V_{OL}	$R_L = 600\ \Omega$ to 0.9 V , $V_{IN} = \pm 100\text{ mV}$		0.077	0.105	
		-40°C to $+125^\circ\text{C}$			0.12	
	V_{OH}	$R_L = 2\text{ k}\Omega$ to 0.9 V , $V_{IN} = \pm 100\text{ mV}$	1.75	1.77		
		-40°C to $+125^\circ\text{C}$	1.74			
	V_{OL}	$R_L = 2\text{ k}\Omega$ to 0.9 V , $V_{IN} = \pm 100\text{ mV}$		0.24	0.035	
		-40°C to $+125^\circ\text{C}$			0.04	
Output Short Circuit Current	I_O	Sourcing, $V_O = 0\text{ V}$, $V_{IN} = +100\text{ mV}$	4.0	30		mA
		-40°C to $+125^\circ\text{C}$	3.3			
		Sinking, $V_O = 1.8\text{ V}$, $V_{IN} = -100\text{ mV}$	7.0	60		
		-40°C to $+125^\circ\text{C}$	5.0			

2. Guaranteed by design and/or characterization.

LMV931, LMV932

1.8 V AC ELECTRICAL CHARACTERISTICS Unless otherwise specified, all limits are guaranteed for $T_A = 25^\circ\text{C}$, $V_S = 1.8\text{ V}$, $V_{CM} = V_S/2$, $V_O = V_S/2$ and $R_L > 1\text{ M}\Omega$. Typical specifications represent the most likely parametric norm. Min/Max specifications are guaranteed by testing, characterization, or statistical analysis.

Parameter	Symbol	Condition	Min	Typ	Max	Unit
Slew Rate	SR	(Note 3)		0.35		V/ μS
Gain Bandwidth Product	GBWP			1.4		MHz
Phase Margin	Θ_m			67		$^\circ$
Gain Margin	Gm			7		dB
Input-Referred Voltage Noise	e_n	$f = 50\text{ kHz}$, $V_{CM} = 0.5\text{ V}$		60		nV/ $\sqrt{\text{Hz}}$
Total Harmonic Distortion	THD	$f = 1\text{ kHz}$, $A_V = +1$, $R_L = 600\ \Omega$, $V_O = 1\text{ V}_{PP}$		0.023		%
Amplifier-to-Amplifier Isolation		(Note 4)		123		dB

3. Connected as voltage follower with input step from V_{EE} to V_{CC} . Number specified is the slower of the positive and negative slew rates.
4. Input referred, $R_L = 100\text{ k}\Omega$ connected to $V_S/2$. Each amp excited in turn with 1 kHz to produce $V_O = 3\text{ V}_{PP}$. (For Supply Voltages $< 3\text{ V}$, $V_O = V_{CC}$).

LMV931, LMV932

2.7 V DC ELECTRICAL CHARACTERISTICS (Note 5) Unless otherwise noted, all min/max limits are guaranteed for $T_A = 25^\circ\text{C}$, $V_S = 2.7\text{ V}$, $V_{CM} = V_S/2$, $V_O = V_S/2$ and $R_L > 1\text{ M}\Omega$. Typical specifications represent the most likely parametric norm.

Parameter	Symbol	Condition	Min	Typ	Max	Unit
Input Offset Voltage	V_{IO}	LMV931 (Single) (-40°C to $+125^\circ\text{C}$)		1	6	mV
		LMV932 (Dual) (-40°C to $+125^\circ\text{C}$)		1	7.5	
Input Offset Voltage Average Drift	TCV_{IO}			5.5		$\mu\text{V}/^\circ\text{C}$
Input Bias Current	I_B	-40°C to $+125^\circ\text{C}$		< 1		nA
Input Offset Current	I_{IO}	-40°C to $+125^\circ\text{C}$		< 1		nA
Supply Current (per Channel)	I_{CC}	In Active Mode		80	190	μA
		-40°C to $+125^\circ\text{C}$			210	
Common Mode Rejection Ratio	CMRR	$0\text{ V} \leq V_{CM} \leq 1.5\text{ V}$, $2.3\text{ V} \leq V_{CM} \leq 2.7\text{ V}$	50	70		dB
		-40°C to $+125^\circ\text{C}$	50			
		$-0.2\text{ V} \leq V_{CM} \leq 0\text{ V}$, $2.7\text{ V} \leq V_{CM} \leq 2.9\text{ V}$	50	70		
Power Supply Rejection Ratio	PSRR	$1.8\text{ V} \leq V^+ \leq 5\text{ V}$, $V_{CM} = 0.5\text{ V}$	50	70		dB
		-40°C to $+125^\circ\text{C}$	50			
Input Common-Mode Voltage Range	VCM	For CMRR $\geq 50\text{ dB}$ and $T_A = 25^\circ\text{C}$	$V_{EE} - 0.2$	-0.2 to 3.0	$V_{CC} + 0.2$	V
		For CMRR $\geq 50\text{ dB}$ and $T_A = -40^\circ\text{C}$ to $+85^\circ\text{C}$	V_{EE}		V_{CC}	
		For CMRR $\geq 50\text{ dB}$ and $T_A = -40^\circ\text{C}$ to $+125^\circ\text{C}$	$V_{EE} + 0.2$		$V_{CC} - 0.2$	
Large Signal Voltage Gain LMV931 (Single)	A_V	$R_L = 600\ \Omega$ to 1.35 V , $V_O = 0.2\text{ V}$ to 2.5 V	87	104		dB
		-40°C to $+125^\circ\text{C}$	86			
		$R_L = 2\text{ k}\Omega$ to 1.35 V , $V_O = 0.2\text{ V}$ to 2.5 V	92	110		
		-40°C to $+125^\circ\text{C}$	91			
Large Signal Voltage Gain LMV932 (Dual)	A_V	$R_L = 600\ \Omega$ to 1.35 V , $V_O = 0.2\text{ V}$ to 2.5 V	78	90		dB
		-40°C to $+125^\circ\text{C}$	75			
		$R_L = 2\text{ k}\Omega$ to 1.35 V , $V_O = 0.2\text{ V}$ to 2.5 V	81	100		
		-40°C to $+125^\circ\text{C}$	78			
Output Swing	V_{OH}	$R_L = 600\ \Omega$ to 1.35 V , $V_{IN} = \pm 100\text{ mV}$	2.55	2.62		V
		-40°C to $+125^\circ\text{C}$	2.53			
	V_{OL}	$R_L = 600\ \Omega$ to 1.35 V , $V_{IN} = \pm 100\text{ mV}$		0.083	0.11	
		-40°C to $+125^\circ\text{C}$			0.13	
	V_{OH}	$R_L = 2\text{ k}\Omega$ to 1.35 V , $V_{IN} = \pm 100\text{ mV}$	2.65	2.675		
		-40°C to $+125^\circ\text{C}$	2.64			
	V_{OL}	$R_L = 2\text{ k}\Omega$ to 1.35 V , $V_{IN} = \pm 100\text{ mV}$		0.025	0.04	
		-40°C to $+125^\circ\text{C}$			0.045	
Output Short Circuit Current	I_O	Sourcing, $V_o = 0\text{ V}$, $V_{IN} = \pm 100\text{ mV}$	20	65		mA
		-40°C to $+125^\circ\text{C}$	15			
		Sinking, $V_o = 0\text{ V}$, $V_{IN} = -100\text{ mV}$	18	75		
		-40°C to $+125^\circ\text{C}$	12			

5. Guaranteed by design and/or characterization.

LMV931, LMV932

2.7 V AC ELECTRICAL CHARACTERISTICS Unless otherwise specified, all limits are guaranteed for $T_A = 25^\circ\text{C}$, $V_S = 2.7\text{ V}$, $V_{CM} = V_S/2$, $V_O = V_S/2$ and $R_L > 1\text{ M}\Omega$. Typical specifications represent the most likely parametric norm. Min/Max specifications are guaranteed by testing, characterization, or statistical analysis.

Parameter	Symbol	Condition	Min	Typ	Max	Unit
Slew Rate	SR	(Note 6)		0.4		V/ μS
Gain Bandwidth Product	GBWP			1.4		MHz
Phase Margin	Θ_m			70		$^\circ$
Gain Margin	Gm			7.5		dB
Input-Referred Voltage Noise	e_n	$f = 50\text{ kHz}$, $V_{CM} = 1.0\text{ V}$		57		nV/ $\sqrt{\text{Hz}}$
Total Harmonic Distortion	THD	$f = 1\text{ kHz}$, $A_V = +1$, $R_L = 600\ \Omega$, $V_O = 1\text{ V}_{PP}$		0.022		%
Amplifier-to-Amplifier Isolation		(Note 7)		123		dB

6. Connected as voltage follower with input step from V_{EE} to V_{CC} . Number specified is the slower of the positive and negative slew rates.
 7. Input referred, $R_L = 100\text{ k}\Omega$ connected to $V_S/2$. Each amp excited in turn with 1 kHz to produce $V_O = 3\text{ V}_{PP}$. (For Supply Voltages $< 3\text{ V}$, $V_O = V_{CC}$).

LMV931, LMV932

5 V DC ELECTRICAL CHARACTERISTICS (Note 8) Unless otherwise noted, all min/max limits are guaranteed for $T_A = 25^\circ\text{C}$, $V_S = 5\text{ V}$, $V_{CM} = V_S/2$, $V_O = V_S/2$ and $R_L > 1\text{ M}\Omega$. Typical specifications represent the most likely parametric norm.

Parameter	Symbol	Condition	Min	Typ	Max	Unit
Input Offset Voltage	V_{IO}	LMV931 (Single) (-40°C to $+125^\circ\text{C}$)		1	6	mV
		LMV932 (Dual) (-40°C to $+125^\circ\text{C}$)		1	7.5	
Input Offset Voltage Average Drift	TCV_{IO}			5.5		$\mu\text{V}/^\circ\text{C}$
Input Bias Current	I_B	-40°C to $+125^\circ\text{C}$		< 1		nA
Input Offset Current	I_{IO}	-40°C to $+125^\circ\text{C}$		< 1		nA
Supply Current (per Channel)	I_{CC}	In Active Mode		95	210	μA
		-40°C to $+125^\circ\text{C}$			230	
Common-Mode Rejection Ratio	CMRR	$0\text{ V} \leq V_{CM} \leq 3.8\text{ V}$, $4.6\text{ V} \leq V_{CM} \leq 5.0\text{ V}$	50	70		dB
		-40°C to $+125^\circ\text{C}$	50			
		$-0.2\text{ V} \leq V_{CM} \leq 0\text{ V}$, $5.0\text{ V} \leq V_{CM} \leq 5.2\text{ V}$	50	70		
Power Supply Rejection Ratio	PSRR	$1.8\text{ V} \leq V^+ \leq 5\text{ V}$, $V_{CM} = 0.5\text{ V}$	50	70		dB
		-40°C to $+125^\circ\text{C}$	50			
Input Common-Mode Voltage Range	VCM	For CMRR $\geq 50\text{ dB}$ and $T_A = 25^\circ\text{C}$	$V_{EE} - 0.2$	-0.2 to 5.3	$V_{CC} + 0.2$	V
		For CMRR $\geq 50\text{ dB}$ and $T_A = -40^\circ\text{C}$ to $+85^\circ\text{C}$	V_{EE}		V_{CC}	
		For CMRR $\geq 50\text{ dB}$ and $T_A = -40^\circ\text{C}$ to $+125^\circ\text{C}$	$V_{EE} + 0.3$		$V_{CC} - 0.3$	
Large Signal Voltage Gain LMV931 (Single)	A_V	$R_L = 600\ \Omega$ to 2.5 V , $V_O = 0.2\text{ V}$ to 4.8 V	88	102		dB
		-40°C to $+125^\circ\text{C}$	87			
		$R_L = 2\text{ k}\Omega$ to 2.5 V , $V_O = 0.2\text{ V}$ to 4.8 V	94	113		
		-40°C to $+125^\circ\text{C}$	93			
Large Signal Voltage Gain LMV932 (Dual)	A_V	$R_L = 600\ \Omega$ to 2.5 V , $V_O = 0.2\text{ V}$ to 4.8 V	81	90		dB
		-40°C to $+125^\circ\text{C}$	78			
		$R_L = 2\text{ k}\Omega$ to 2.5 V , $V_O = 0.2\text{ V}$ to 4.8 V	85	100		
		-40°C to $+125^\circ\text{C}$	82			
Output Swing	V_{OH}	$R_L = 600\ \Omega$ to 2.5 V , $V_{IN} = \pm 100\text{ mV}$	4.855	4.89		V
		-40°C to $+125^\circ\text{C}$	4.835			
	V_{OL}	$R_L = 600\ \Omega$ to 2.5 V , $V_{IN} = \pm 100\text{ mV}$		0.12	0.16	
		-40°C to $+125^\circ\text{C}$			0.18	
	V_{OH}	$R_L = 2\text{ k}\Omega$ to 2.5 V , $V_{IN} = \pm 100\text{ mV}$	4.945	4.967		
		-40°C to $+125^\circ\text{C}$	4.935			
	V_{OL}	$R_L = 2\text{ k}\Omega$ to 2.5 V , $V_{IN} = \pm 100\text{ mV}$		0.037	0.065	
		-40°C to $+125^\circ\text{C}$			0.075	
Output Short-Circuit Current	I_O	Sourcing, $V_O = 0\text{ V}$, $V_{IN} = +100\text{ mV}$	55	65		mA
		-40°C to $+125^\circ\text{C}$	45			
		Sinking, $V_O = 5\text{ V}$, $V_{IN} = -100\text{ mV}$	58	80		
		-40°C to $+125^\circ\text{C}$	45			

8. Guaranteed by design and/or characterization.

LMV931, LMV932

5 V AC ELECTRICAL CHARACTERISTICS Unless otherwise specified, all limits are guaranteed for $T_A = 25^\circ\text{C}$, $V_S = 5\text{ V}$, $V_{CM} = V_S/2$, $V_O = V_S/2$ and $R_L > 1\text{ M}\Omega$. Typical specifications represent the most likely parametric norm.

Parameter	Symbol	Condition	Min	Typ	Max	Unit
Slew Rate	SR	(Note 9)		0.48		V/ μS
Gain Bandwidth Product	GBWP			1.5		MHz
Phase Margin	Θ_m			65		$^\circ$
Gain Margin	Gm			8		dB
Input-Referred Voltage Noise	e_n	$f = 50\text{ kHz}$, $V_{CM} = 2\text{ V}$		50		nV/ $\sqrt{\text{Hz}}$
Total Harmonic Distortion	THD	$f = 1\text{ kHz}$, $A_V = +1$, $R_L = 600\ \Omega$, $V_O = 1\text{ V}_{PP}$		0.022		%
Amplifier-to-Amplifier Isolation		(Note 10)		123		dB

9. Connected as voltage follower with input step from V_{EE} to V_{CC} . Number specified is the slower of the positive and negative slew rates.

10. Input referred, $R_L = 100\text{ k}\Omega$ connected to $V_S/2$. Each amp excited in turn with 1 kHz to produce $V_O = 3\text{ V}_{PP}$. (For Supply Voltages $< 3\text{ V}$, $V_O = V_{CC}$).

LMV931, LMV932

TYPICAL CHARACTERISTICS

($T_A = 25^\circ\text{C}$ and $V_S = 5\text{ V}$ unless otherwise specified)

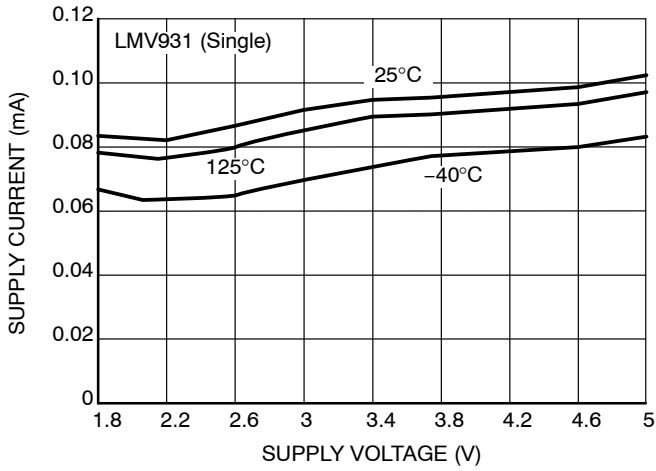

Figure 2. Supply Current vs. Supply Voltage

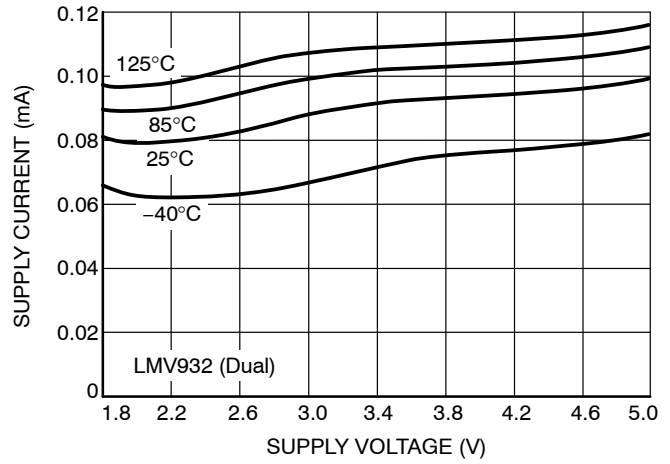

Figure 3. Supply Current vs. Supply Voltage

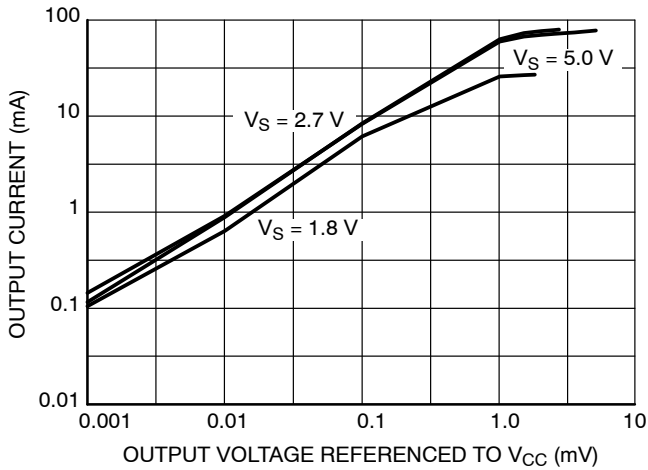

Figure 4. Sourcing Current vs. Output Voltage
($T_A = 25^\circ\text{C}$)

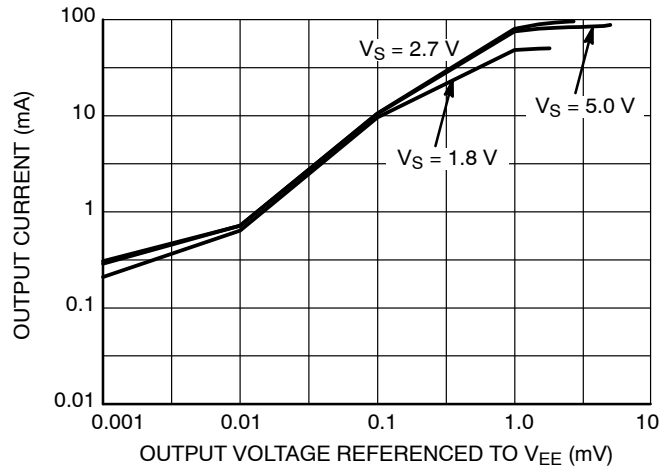

Figure 5. Sinking Current vs. Output Voltage
($T_A = 25^\circ\text{C}$)

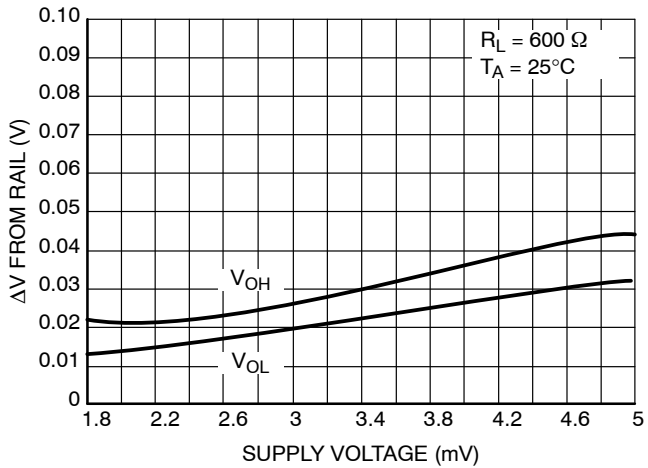

Figure 6. Output Voltage Swing vs. Supply Voltage

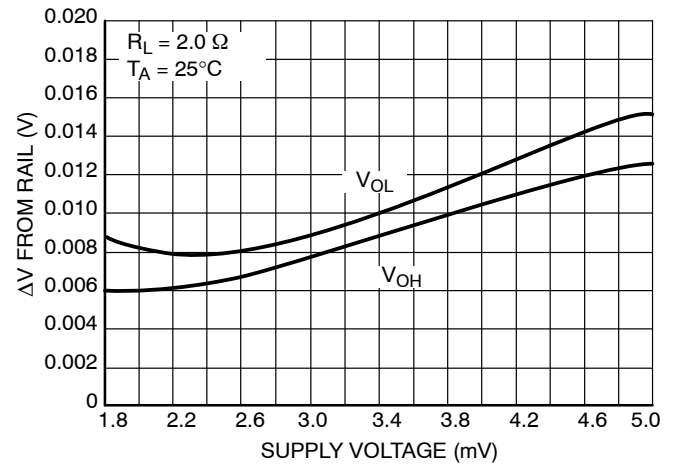

Figure 7. Output Voltage vs. Supply Voltage

LMV931, LMV932

TYPICAL CHARACTERISTICS

($T_A = 25^\circ\text{C}$ and $V_S = 5\text{ V}$ unless otherwise specified)

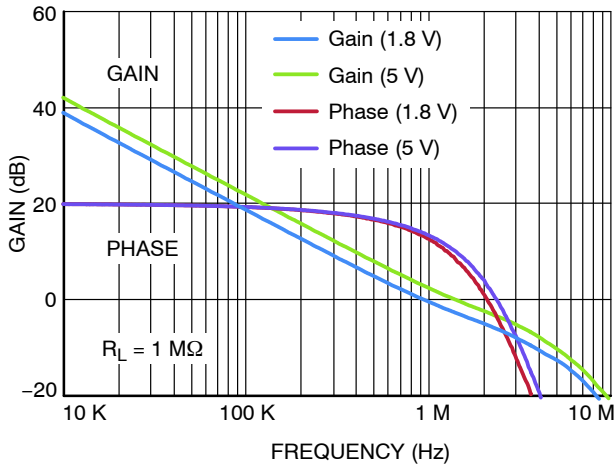

Figure 8. Open Loop Gain and Phase

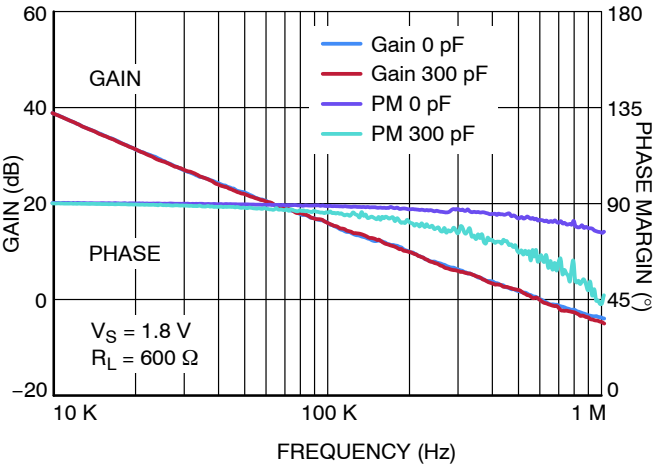

Figure 9. Frequency Response vs. CL

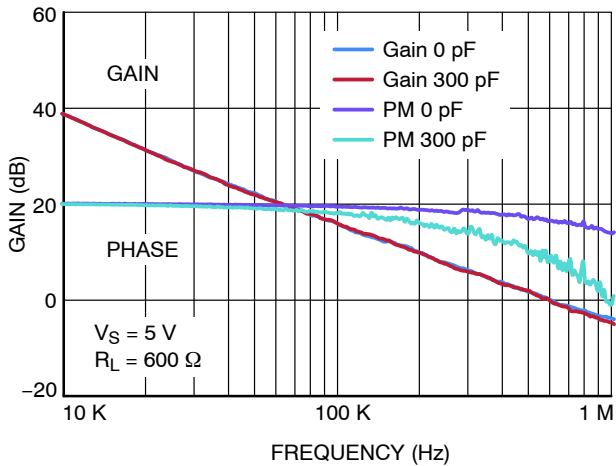

Figure 10. Frequency Response vs. CL

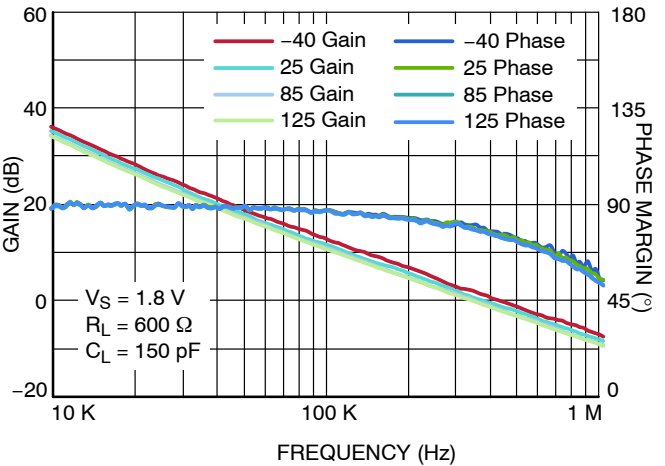

Figure 11. Gain and Phase vs. Temp

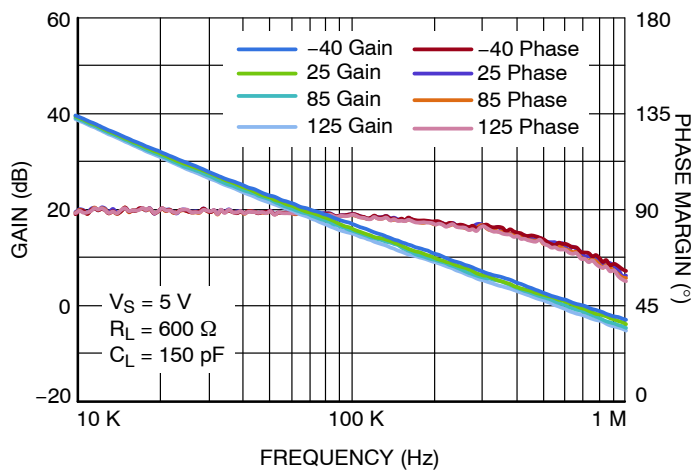

Figure 12. Gain and Phase vs. Temp

LMV931, LMV932

TYPICAL CHARACTERISTICS

($T_A = 25^\circ\text{C}$ and $V_S = 5\text{ V}$ unless otherwise specified)

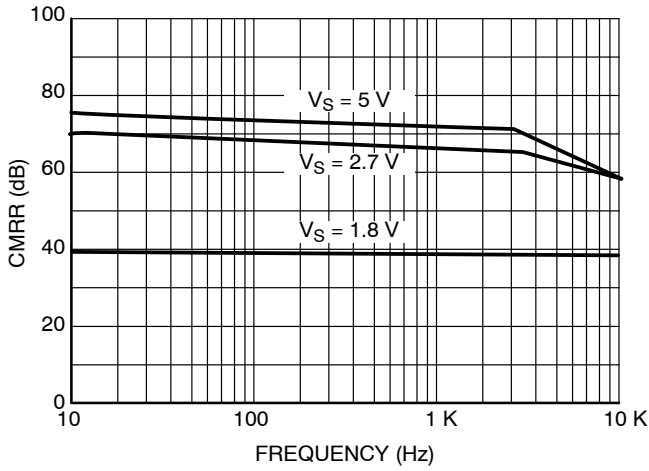

Figure 13. CMRR vs. Frequency

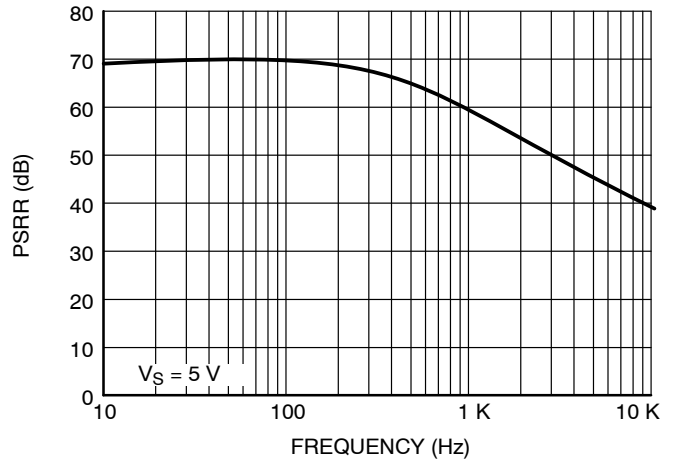

Figure 14. PSRR vs. Frequency

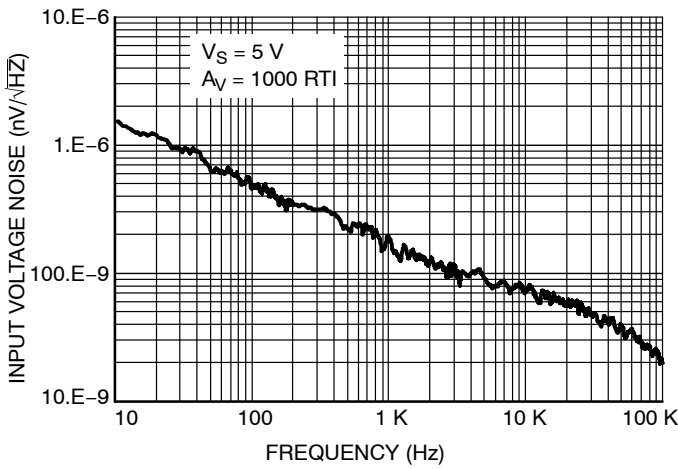

Figure 15. Input Voltage Noise vs. Frequency

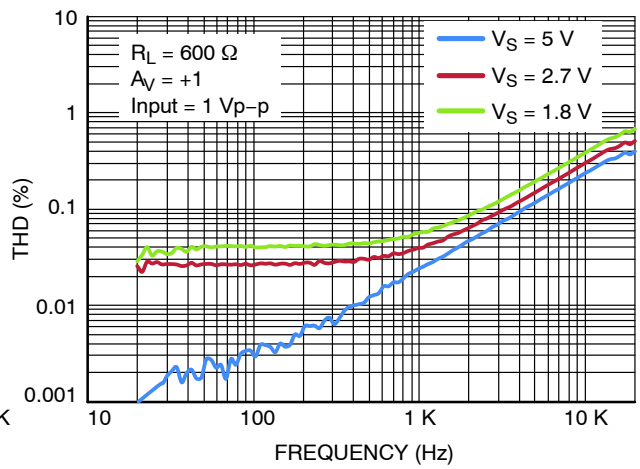

Figure 16. THD vs. Frequency

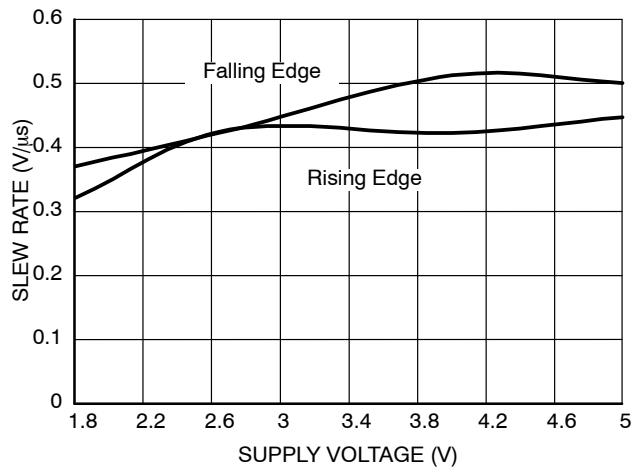

Figure 17. Slew Rate vs. Supply Voltage

LMV931, LMV932

TYPICAL CHARACTERISTICS

($T_A = 25^\circ\text{C}$ and $V_S = 5\text{ V}$ unless otherwise specified)

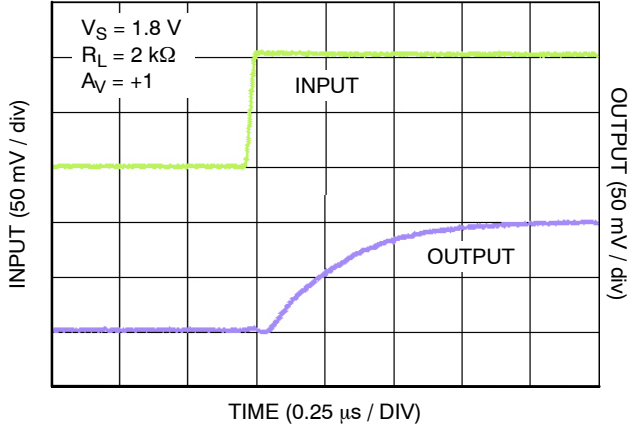

Figure 18. Small Signal Transient Response

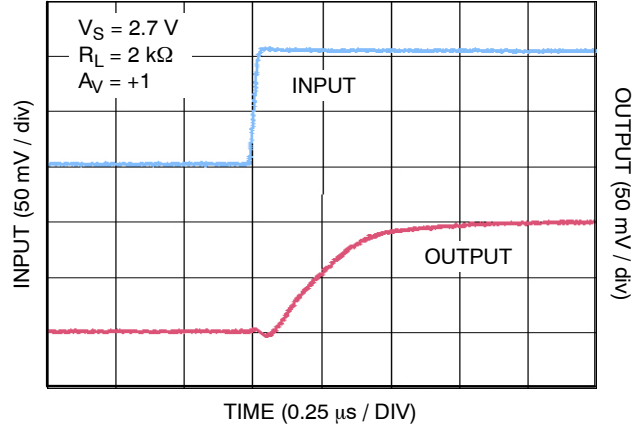

Figure 19. Small Signal Transient Response

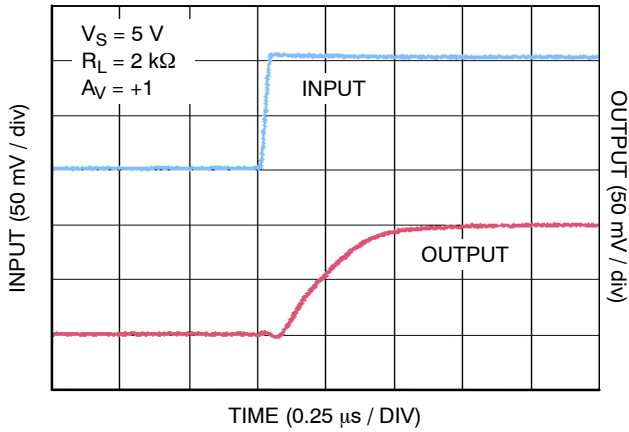

Figure 20. Small Signal Transient Response

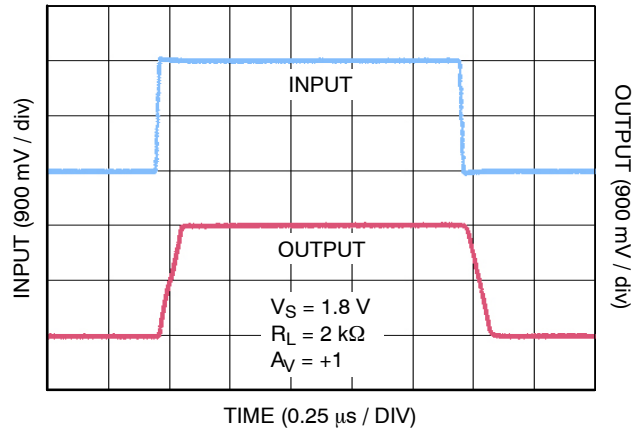

Figure 21. Large Signal Transient Response

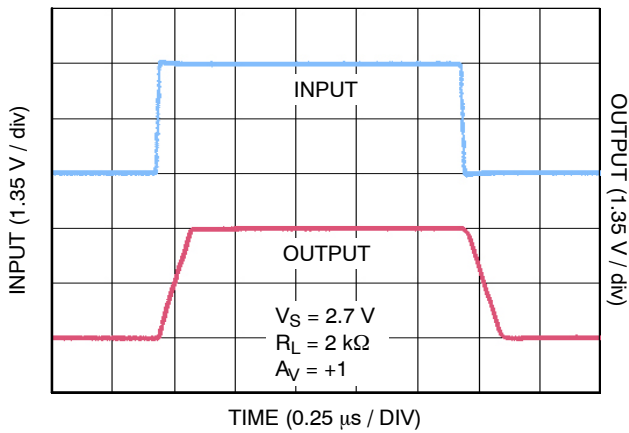

Figure 22. Large Signal Transient Response

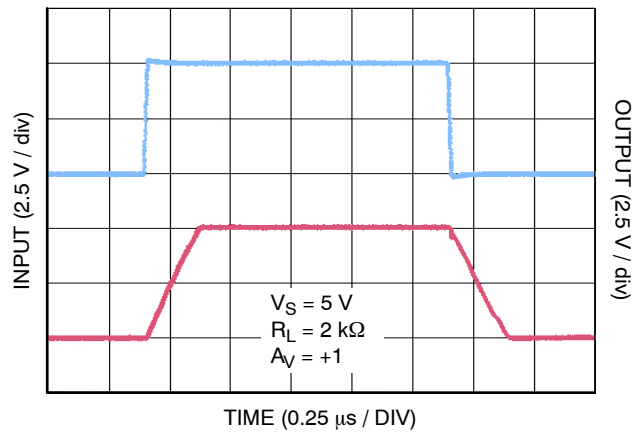

Figure 23. Large Signal Transient Response

LMV931, LMV932

TYPICAL CHARACTERISTICS

($T_A = 25^\circ\text{C}$ and $V_S = 5\text{ V}$ unless otherwise specified)

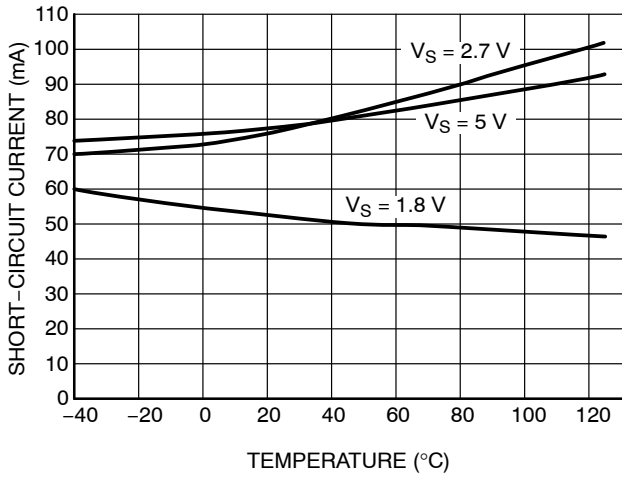

Figure 24. Short-Circuit vs. Temperature (Sinking)

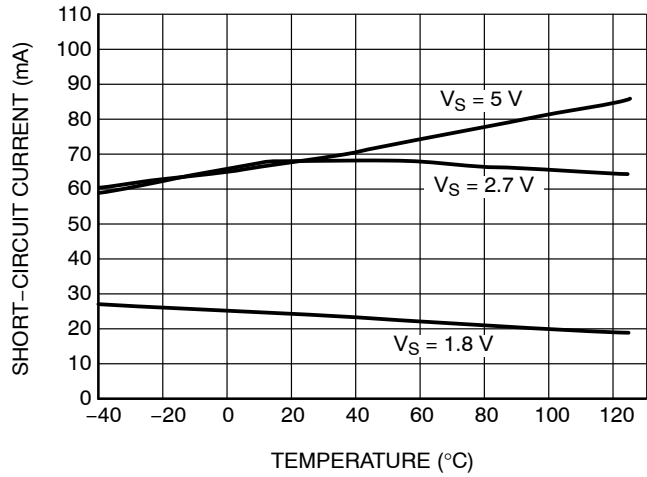

Figure 25. Short-Circuit vs. Temperature (Sourcing)

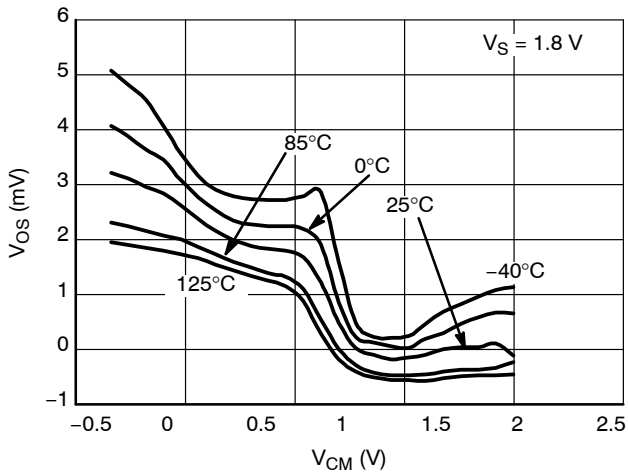

Figure 26. Offset Voltage vs. Common Mode Range V_{DD}

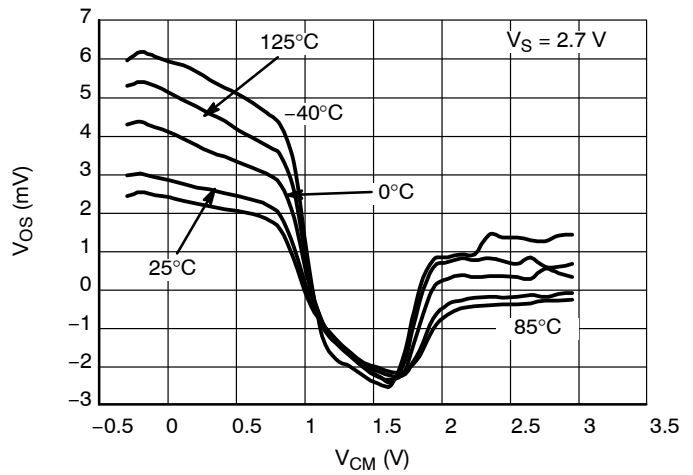

Figure 27. Offset Voltage vs. Common Mode Range

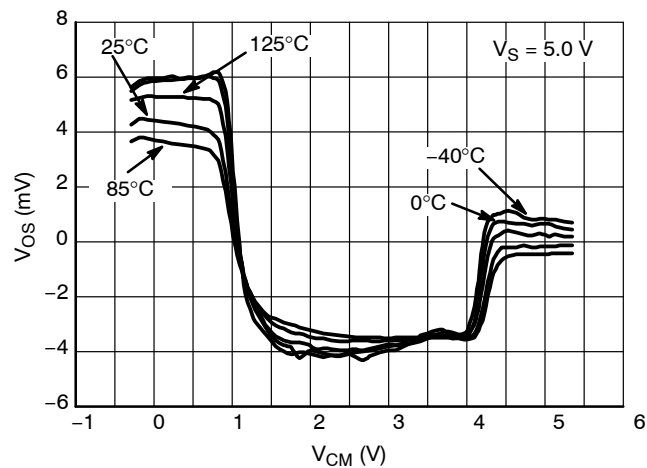

Figure 28. Offset Voltage vs. Common Mode Range

LMV931, LMV932

APPLICATION INFORMATION

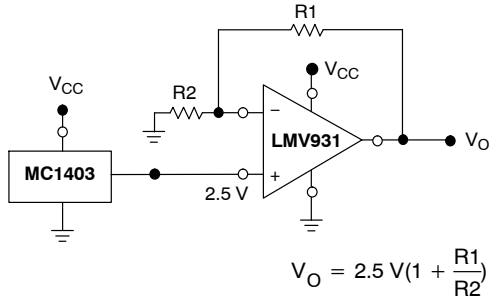

Figure 29. Voltage Reference

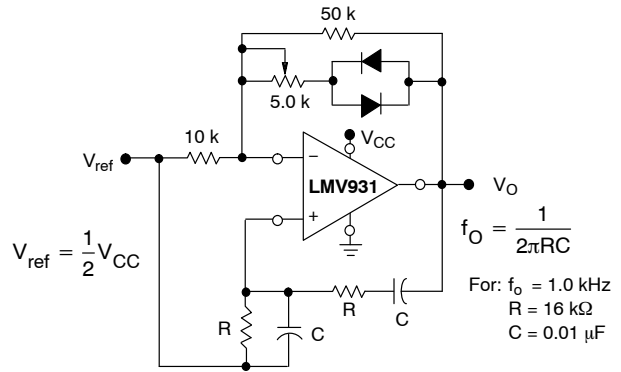

Figure 30. Wien Bridge Oscillator

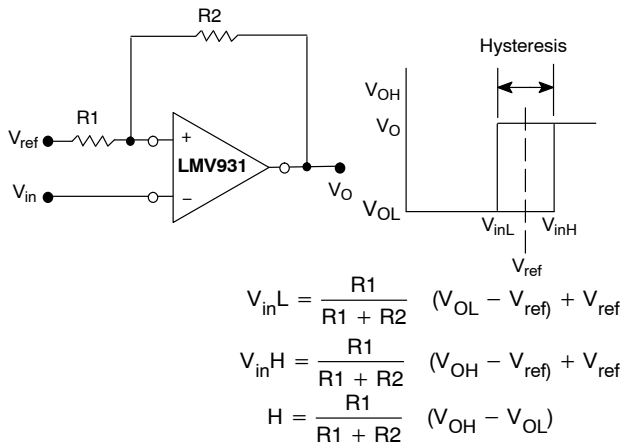
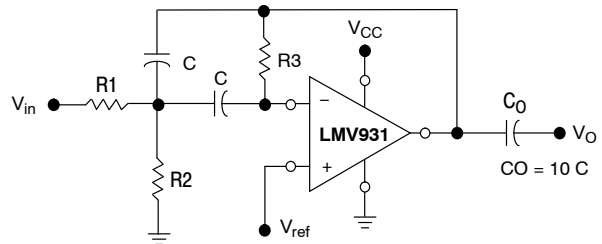

Figure 31. Comparator with Hysteresis



Given: f_o = center frequency
 $A(f_o)$ = gain at center frequency

Choose value f_o, C
 Then: $R_3 = \frac{Q}{\pi f_o C}$
 $R_1 = \frac{R_3}{2 A(f_o)}$
 $R_2 = \frac{R_1 R_3}{4Q^2 R_1 - R_3}$

For less than 10% error from operational amplifier,
 $((Q_o f_o)/BW) < 0.1$ where f_o and BW are expressed in Hz.
 If source impedance varies, filter may be preceded with
 voltage follower buffer to stabilize filter parameters.

Figure 32. Multiple Feedback Bandpass Filter

ORDERING INFORMATION

Order Number	Number of Channels	Number of Pins	Package Type	Shipping†
LMV931SQ3T2G	Single	5	SC70-5 (Pb-Free)	3000 / Tape & Reel
LMV931SN3T1G	Single	5	TSOP-5 (Pb-Free)	3000 / Tape & Reel
LMV932DMR2G*	Dual	8	Micro8 (Pb-Free)	4000 / Tape & Reel
LMV932DR2G	Dual	8	SOIC-8 (Pb-Free)	2500 / Tape & Reel

†For information on tape and reel specifications, including part orientation and tape sizes, please refer to our Tape and Reel Packaging Specifications Brochure, BRD8011/D.

*Consult Sales.

Micro8 is a trademark of International Rectifier.

MECHANICAL CASE OUTLINE

PACKAGE DIMENSIONS

ON Semiconductor®



SC-88A (SC-70-5/SOT-353) CASE 419A-02 ISSUE L

SCALE 2:1

DATE 17 JAN 2013

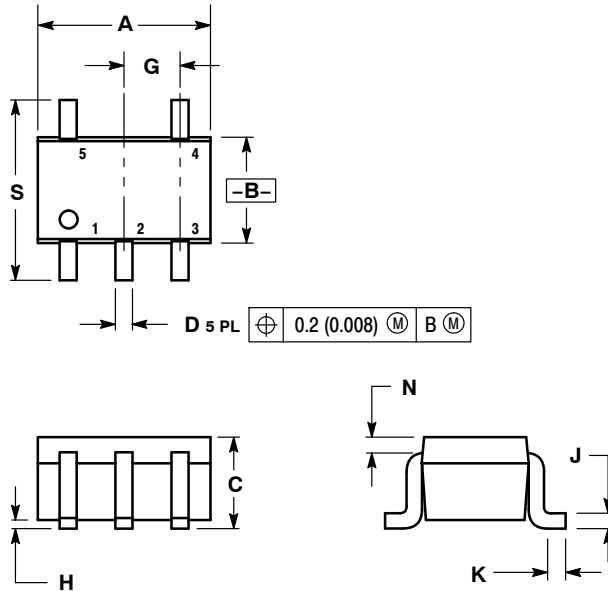

NOTES:

1. DIMENSIONING AND TOLERANCING PER ANSI Y14.5M, 1982.
2. CONTROLLING DIMENSION: INCH.
3. 419A-01 OBSOLETE. NEW STANDARD 419A-02.
4. DIMENSIONS A AND B DO NOT INCLUDE MOLD FLASH, PROTRUSIONS, OR GATE BURRS.

DIM	INCHES		MILLIMETERS	
	MIN	MAX	MIN	MAX
A	0.071	0.087	1.80	2.20
B	0.045	0.053	1.15	1.35
C	0.031	0.043	0.80	1.10
D	0.004	0.012	0.10	0.30
G	0.026 BSC		0.65 BSC	
H	---	0.004	---	0.10
J	0.004	0.010	0.10	0.25
K	0.004	0.012	0.10	0.30
N	0.008 REF		0.20 REF	
S	0.079	0.087	2.00	2.20

GENERIC MARKING DIAGRAM*

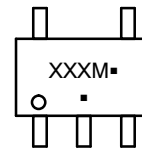

- XXX = Specific Device Code
- M = Date Code
- = Pb-Free Package

(Note: Microdot may be in either location)

*This information is generic. Please refer to device data sheet for actual part marking.

SOLDER FOOTPRINT

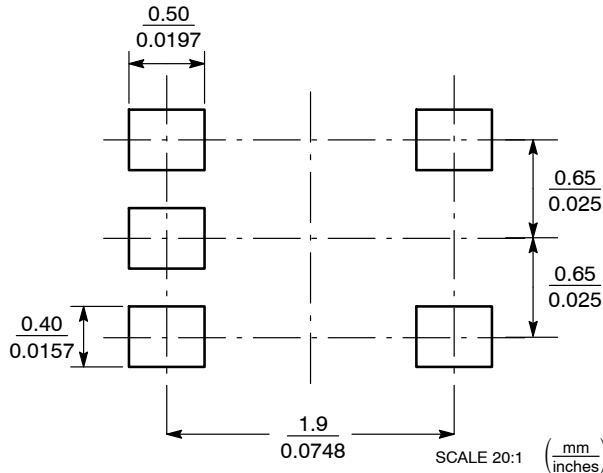

STYLE 1:
PIN 1. BASE
2. EMITTER
3. BASE
4. COLLECTOR
5. COLLECTOR

STYLE 2:
PIN 1. ANODE
2. EMITTER
3. BASE
4. COLLECTOR
5. CATHODE

STYLE 3:
PIN 1. ANODE 1
2. N/C
3. ANODE 2
4. CATHODE 2
5. CATHODE 1

STYLE 4:
PIN 1. SOURCE 1
2. DRAIN 1/2
3. SOURCE 1
4. GATE 1
5. GATE 2

STYLE 5:
PIN 1. CATHODE
2. COMMON ANODE
3. CATHODE 2
4. CATHODE 3
5. CATHODE 4

STYLE 6:
PIN 1. EMITTER 2
2. BASE 2
3. EMITTER 1
4. COLLECTOR
5. COLLECTOR 2/BASE 1

STYLE 7:
PIN 1. BASE
2. EMITTER
3. BASE
4. COLLECTOR
5. COLLECTOR

STYLE 8:
PIN 1. CATHODE
2. COLLECTOR
3. N/C
4. BASE
5. EMITTER

STYLE 9:
PIN 1. ANODE
2. CATHODE
3. ANODE
4. ANODE
5. ANODE

DOCUMENT NUMBER:	98ASB42984B	Electronic versions are uncontrolled except when accessed directly from the Document Repository. Printed versions are uncontrolled except when stamped "CONTROLLED COPY" in red.
STATUS:	ON SEMICONDUCTOR STANDARD	
NEW STANDARD:		
DESCRIPTION:	SC-88A (SC-70-5/SOT-353)	PAGE 1 OF 2



ISSUE	REVISION	DATE
C	CONVERTED FROM PAPER DOCUMENT TO ELECTRONIC. REQ. BY N LAFEB-RE.	20 JUN 1998
D	CONVERTED FROM MOTOROLA TO ON SEMICONDUCTOR. ADDED STYLE 5. REQ. BY E. KIM.	24 JUL 2000
E	ADDED STYLES 6 & 7. REQ. BY S. BACHMAN.	03 AUG 2000
F	DELETED DIMENSION V, WAS 0.3–0.44MM/0.012–0.016IN. REQ. BY G. KWONG.	14 JUN 2001
G	ADDED STYLE 8, REQ. BY S. CHANG; ADDED STYLE 9, REQ. BY S. BACHMAN; ADDED NOTE 4, REQ. BY S. RIGGS	25 JUN 2003
H	CHANGED STYLE 6. REQ. BY C. LIM	28 APR 2005
J	CHANGED TITLE DESCRIPTION. REQ. BY B. LOFTS.	31 AUG 2005
K	CORRECTED TITLE AND DESCRIPTION TO SC-88A (SC-70-5/SOT-353). CORRECTED MARKING DIAGRAM. REQ. BY D. TRUHITTE.	13 JUL 2010
L	ADDED SOLDER FOOTPRINT. REQ. BY I. MARIANO.	17 JAN 2013

ON Semiconductor and  are registered trademarks of Semiconductor Components Industries, LLC (SCILLC). SCILLC reserves the right to make changes without further notice to any products herein. SCILLC makes no warranty, representation or guarantee regarding the suitability of its products for any particular purpose, nor does SCILLC assume any liability arising out of the application or use of any product or circuit, and specifically disclaims any and all liability, including without limitation special, consequential or incidental damages. "Typical" parameters which may be provided in SCILLC data sheets and/or specifications can and do vary in different applications and actual performance may vary over time. All operating parameters, including "Typicals" must be validated for each customer application by customer's technical experts. SCILLC does not convey any license under its patent rights nor the rights of others. SCILLC products are not designed, intended, or authorized for use as components in systems intended for surgical implant into the body, or other applications intended to support or sustain life, or for any other application in which the failure of the SCILLC product could create a situation where personal injury or death may occur. Should Buyer purchase or use SCILLC products for any such unintended or unauthorized application, Buyer shall indemnify and hold SCILLC and its officers, employees, subsidiaries, affiliates, and distributors harmless against all claims, costs, damages, and expenses, and reasonable attorney fees arising out of, directly or indirectly, any claim of personal injury or death associated with such unintended or unauthorized use, even if such claim alleges that SCILLC was negligent regarding the design or manufacture of the part. SCILLC is an Equal Opportunity/Affirmative Action Employer. This literature is subject to all applicable copyright laws and is not for resale in any manner.

MECHANICAL CASE OUTLINE PACKAGE DIMENSIONS

ON Semiconductor®



SCALE 2:1

TSOP-5 CASE 483 ISSUE N

DATE 12 AUG 2020



NOTES:

1. DIMENSIONING AND TOLERANCING PER ASME Y14.5M, 1994.
2. CONTROLLING DIMENSION: MILLIMETERS.
3. MAXIMUM LEAD THICKNESS INCLUDES LEAD FINISH THICKNESS. MINIMUM LEAD THICKNESS IS THE MINIMUM THICKNESS OF BASE MATERIAL.
4. DIMENSIONS A AND B DO NOT INCLUDE MOLD FLASH, PROTRUSIONS, OR GATE BURRS. MOLD FLASH, PROTRUSIONS, OR GATE BURRS SHALL NOT EXCEED 0.15 PER SIDE. DIMENSION A.
5. OPTIONAL CONSTRUCTION: AN ADDITIONAL TRIMMED LEAD IS ALLOWED IN THIS LOCATION. TRIMMED LEAD NOT TO EXTEND MORE THAN 0.2 FROM BODY.

DIM	MILLIMETERS	
	MIN	MAX
A	2.85	3.15
B	1.35	1.65
C	0.90	1.10
D	0.25	0.50
G	0.95 BSC	
H	0.01	0.10
J	0.10	0.26
K	0.20	0.60
M	0°	10°
S	2.50	3.00

SOLDERING FOOTPRINT*

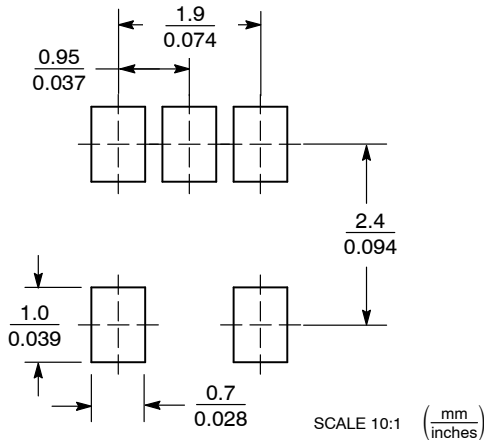

*For additional information on our Pb-Free strategy and soldering details, please download the ON Semiconductor Soldering and Mounting Techniques Reference Manual, SOLDERRM/D.

GENERIC MARKING DIAGRAM*

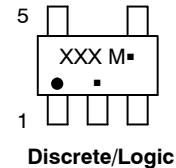
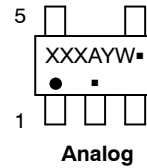

- XXX = Specific Device Code
 A = Assembly Location
 Y = Year
 W = Work Week
 ■ = Pb-Free Package
- XXX = Specific Device Code
 M = Date Code
 ■ = Pb-Free Package

(Note: Microdot may be in either location)

*This information is generic. Please refer to device data sheet for actual part marking. Pb-Free indicator, "G" or microdot "■", may or may not be present.

DOCUMENT NUMBER:	98ARB18753C	Electronic versions are uncontrolled except when accessed directly from the Document Repository. Printed versions are uncontrolled except when stamped "CONTROLLED COPY" in red.
DESCRIPTION:	TSOP-5	PAGE 1 OF 1

ON Semiconductor and ON are trademarks of Semiconductor Components Industries, LLC dba ON Semiconductor or its subsidiaries in the United States and/or other countries. ON Semiconductor reserves the right to make changes without further notice to any products herein. ON Semiconductor makes no warranty, representation or guarantee regarding the suitability of its products for any particular purpose, nor does ON Semiconductor assume any liability arising out of the application or use of any product or circuit, and specifically disclaims any and all liability, including without limitation special, consequential or incidental damages. ON Semiconductor does not convey any license under its patent rights nor the rights of others.

MECHANICAL CASE OUTLINE PACKAGE DIMENSIONS

ON Semiconductor®



SCALE 1:1

SOIC-8 NB
CASE 751-07
ISSUE AK

DATE 16 FEB 2011



- NOTES:
1. DIMENSIONING AND TOLERANCING PER ANSI Y14.5M, 1982.
 2. CONTROLLING DIMENSION: MILLIMETER.
 3. DIMENSION A AND B DO NOT INCLUDE MOLD PROTRUSION.
 4. MAXIMUM MOLD PROTRUSION 0.15 (0.006) PER SIDE.
 5. DIMENSION D DOES NOT INCLUDE DAMBAR PROTRUSION. ALLOWABLE DAMBAR PROTRUSION SHALL BE 0.127 (0.005) TOTAL IN EXCESS OF THE D DIMENSION AT MAXIMUM MATERIAL CONDITION.
 6. 751-01 THRU 751-06 ARE OBSOLETE. NEW STANDARD IS 751-07.

DIM	MILLIMETERS		INCHES	
	MIN	MAX	MIN	MAX
A	4.80	5.00	0.189	0.197
B	3.80	4.00	0.150	0.157
C	1.35	1.75	0.053	0.069
D	0.33	0.51	0.013	0.020
G	1.27 BSC		0.050 BSC	
H	0.10	0.25	0.004	0.010
J	0.19	0.25	0.007	0.010
K	0.40	1.27	0.016	0.050
M	0°	8°	0°	8°
N	0.25	0.50	0.010	0.020
S	5.80	6.20	0.228	0.244

SOLDERING FOOTPRINT*



*For additional information on our Pb-Free strategy and soldering details, please download the ON Semiconductor Soldering and Mounting Techniques Reference Manual, SOLDERRM/D.

GENERIC MARKING DIAGRAM*



XXXXXX = Specific Device Code
 A = Assembly Location
 L = Wafer Lot
 Y = Year
 W = Work Week
 ■ = Pb-Free Package

XXXXXX = Specific Device Code
 A = Assembly Location
 Y = Year
 WW = Work Week
 ■ = Pb-Free Package

*This information is generic. Please refer to device data sheet for actual part marking. Pb-Free indicator, "G" or microdot "•", may or may not be present. Some products may not follow the Generic Marking.

STYLES ON PAGE 2

DOCUMENT NUMBER:	98ASB42564B	Electronic versions are uncontrolled except when accessed directly from the Document Repository. Printed versions are uncontrolled except when stamped "CONTROLLED COPY" in red.
DESCRIPTION:	SOIC-8 NB	PAGE 1 OF 2

ON Semiconductor and ON are trademarks of Semiconductor Components Industries, LLC dba ON Semiconductor or its subsidiaries in the United States and/or other countries. ON Semiconductor reserves the right to make changes without further notice to any products herein. ON Semiconductor makes no warranty, representation or guarantee regarding the suitability of its products for any particular purpose, nor does ON Semiconductor assume any liability arising out of the application or use of any product or circuit, and specifically disclaims any and all liability, including without limitation special, consequential or incidental damages. ON Semiconductor does not convey any license under its patent rights nor the rights of others.

SOIC-8 NB
CASE 751-07
ISSUE AK

DATE 16 FEB 2011

- | | | | |
|--|---|---|---|
| <p>STYLE 1:
 PIN 1. EMITTER
 2. COLLECTOR
 3. COLLECTOR
 4. EMITTER
 5. EMITTER
 6. BASE
 7. BASE
 8. EMITTER</p> | <p>STYLE 2:
 PIN 1. COLLECTOR, DIE, #1
 2. COLLECTOR, #1
 3. COLLECTOR, #2
 4. COLLECTOR, #2
 5. BASE, #2
 6. EMITTER, #2
 7. BASE, #1
 8. EMITTER, #1</p> | <p>STYLE 3:
 PIN 1. DRAIN, DIE #1
 2. DRAIN, #1
 3. DRAIN, #2
 4. DRAIN, #2
 5. GATE, #2
 6. SOURCE, #2
 7. GATE, #1
 8. SOURCE, #1</p> | <p>STYLE 4:
 PIN 1. ANODE
 2. ANODE
 3. ANODE
 4. ANODE
 5. ANODE
 6. ANODE
 7. ANODE
 8. COMMON CATHODE</p> |
| <p>STYLE 5:
 PIN 1. DRAIN
 2. DRAIN
 3. DRAIN
 4. DRAIN
 5. GATE
 6. GATE
 7. SOURCE
 8. SOURCE</p> | <p>STYLE 6:
 PIN 1. SOURCE
 2. DRAIN
 3. DRAIN
 4. SOURCE
 5. SOURCE
 6. GATE
 7. GATE
 8. SOURCE</p> | <p>STYLE 7:
 PIN 1. INPUT
 2. EXTERNAL BYPASS
 3. THIRD STAGE SOURCE
 4. GROUND
 5. DRAIN
 6. GATE 3
 7. SECOND STAGE Vd
 8. FIRST STAGE Vd</p> | <p>STYLE 8:
 PIN 1. COLLECTOR, DIE #1
 2. BASE, #1
 3. BASE, #2
 4. COLLECTOR, #2
 5. COLLECTOR, #2
 6. EMITTER, #2
 7. EMITTER, #1
 8. COLLECTOR, #1</p> |
| <p>STYLE 9:
 PIN 1. EMITTER, COMMON
 2. COLLECTOR, DIE #1
 3. COLLECTOR, DIE #2
 4. EMITTER, COMMON
 5. EMITTER, COMMON
 6. BASE, DIE #2
 7. BASE, DIE #1
 8. EMITTER, COMMON</p> | <p>STYLE 10:
 PIN 1. GROUND
 2. BIAS 1
 3. OUTPUT
 4. GROUND
 5. GROUND
 6. BIAS 2
 7. INPUT
 8. GROUND</p> | <p>STYLE 11:
 PIN 1. SOURCE 1
 2. GATE 1
 3. SOURCE 2
 4. GATE 2
 5. DRAIN 2
 6. DRAIN 2
 7. DRAIN 1
 8. DRAIN 1</p> | <p>STYLE 12:
 PIN 1. SOURCE
 2. SOURCE
 3. SOURCE
 4. GATE
 5. DRAIN
 6. DRAIN
 7. DRAIN
 8. DRAIN</p> |
| <p>STYLE 13:
 PIN 1. N.C.
 2. SOURCE
 3. SOURCE
 4. GATE
 5. DRAIN
 6. DRAIN
 7. DRAIN
 8. DRAIN</p> | <p>STYLE 14:
 PIN 1. N-SOURCE
 2. N-GATE
 3. P-SOURCE
 4. P-GATE
 5. P-DRAIN
 6. P-DRAIN
 7. N-DRAIN
 8. N-DRAIN</p> | <p>STYLE 15:
 PIN 1. ANODE 1
 2. ANODE 1
 3. ANODE 1
 4. ANODE 1
 5. CATHODE, COMMON
 6. CATHODE, COMMON
 7. CATHODE, COMMON
 8. CATHODE, COMMON</p> | <p>STYLE 16:
 PIN 1. EMITTER, DIE #1
 2. BASE, DIE #1
 3. EMITTER, DIE #2
 4. BASE, DIE #2
 5. COLLECTOR, DIE #2
 6. COLLECTOR, DIE #2
 7. COLLECTOR, DIE #1
 8. COLLECTOR, DIE #1</p> |
| <p>STYLE 17:
 PIN 1. VCC
 2. V2OUT
 3. V1OUT
 4. TXE
 5. RXE
 6. VEE
 7. GND
 8. ACC</p> | <p>STYLE 18:
 PIN 1. ANODE
 2. ANODE
 3. SOURCE
 4. GATE
 5. DRAIN
 6. DRAIN
 7. CATHODE
 8. CATHODE</p> | <p>STYLE 19:
 PIN 1. SOURCE 1
 2. GATE 1
 3. SOURCE 2
 4. GATE 2
 5. DRAIN 2
 6. MIRROR 2
 7. DRAIN 1
 8. MIRROR 1</p> | <p>STYLE 20:
 PIN 1. SOURCE (N)
 2. GATE (N)
 3. SOURCE (P)
 4. GATE (P)
 5. DRAIN
 6. DRAIN
 7. DRAIN
 8. DRAIN</p> |
| <p>STYLE 21:
 PIN 1. CATHODE 1
 2. CATHODE 2
 3. CATHODE 3
 4. CATHODE 4
 5. CATHODE 5
 6. COMMON ANODE
 7. COMMON ANODE
 8. CATHODE 6</p> | <p>STYLE 22:
 PIN 1. I/O LINE 1
 2. COMMON CATHODE/VCC
 3. COMMON CATHODE/VCC
 4. I/O LINE 3
 5. COMMON ANODE/GND
 6. I/O LINE 4
 7. I/O LINE 5
 8. COMMON ANODE/GND</p> | <p>STYLE 23:
 PIN 1. LINE 1 IN
 2. COMMON ANODE/GND
 3. COMMON ANODE/GND
 4. LINE 2 IN
 5. LINE 2 OUT
 6. COMMON ANODE/GND
 7. COMMON ANODE/GND
 8. LINE 1 OUT</p> | <p>STYLE 24:
 PIN 1. BASE
 2. EMITTER
 3. COLLECTOR/ANODE
 4. COLLECTOR/ANODE
 5. CATHODE
 6. CATHODE
 7. COLLECTOR/ANODE
 8. COLLECTOR/ANODE</p> |
| <p>STYLE 25:
 PIN 1. VIN
 2. N/C
 3. REXT
 4. GND
 5. IOUT
 6. IOUT
 7. IOUT
 8. IOUT</p> | <p>STYLE 26:
 PIN 1. GND
 2. dv/dt
 3. ENABLE
 4. ILIMIT
 5. SOURCE
 6. SOURCE
 7. SOURCE
 8. VCC</p> | <p>STYLE 27:
 PIN 1. ILIMIT
 2. OVLO
 3. UVLO
 4. INPUT+
 5. SOURCE
 6. SOURCE
 7. SOURCE
 8. DRAIN</p> | <p>STYLE 28:
 PIN 1. SW_TO_GND
 2. DASIC OFF
 3. DASIC_SW_DET
 4. GND
 5. V_MON
 6. VBULK
 7. VBULK
 8. VIN</p> |
| <p>STYLE 29:
 PIN 1. BASE, DIE #1
 2. EMITTER, #1
 3. BASE, #2
 4. EMITTER, #2
 5. COLLECTOR, #2
 6. COLLECTOR, #2
 7. COLLECTOR, #1
 8. COLLECTOR, #1</p> | <p>STYLE 30:
 PIN 1. DRAIN 1
 2. DRAIN 1
 3. GATE 2
 4. SOURCE 2
 5. SOURCE 1/DRAIN 2
 6. SOURCE 1/DRAIN 2
 7. SOURCE 1/DRAIN 2
 8. GATE 1</p> | | |

DOCUMENT NUMBER:	98ASB42564B	Electronic versions are uncontrolled except when accessed directly from the Document Repository. Printed versions are uncontrolled except when stamped "CONTROLLED COPY" in red.
DESCRIPTION:	SOIC-8 NB	PAGE 2 OF 2

ON Semiconductor and  are trademarks of Semiconductor Components Industries, LLC dba ON Semiconductor or its subsidiaries in the United States and/or other countries. ON Semiconductor reserves the right to make changes without further notice to any products herein. ON Semiconductor makes no warranty, representation or guarantee regarding the suitability of its products for any particular purpose, nor does ON Semiconductor assume any liability arising out of the application or use of any product or circuit, and specifically disclaims any and all liability, including without limitation special, consequential or incidental damages. ON Semiconductor does not convey any license under its patent rights nor the rights of others.

MECHANICAL CASE OUTLINE

PACKAGE DIMENSIONS

ON Semiconductor®



SCALE 2:1

Micro8 CASE 846A-02 ISSUE K

DATE 16 JUL 2020



TOP VIEW

NOTE 3



SIDE VIEW



END VIEW

NOTES:

1. DIMENSIONING AND TOLERANCING PER ASME Y14.5M, 2009.
2. CONTROLLING DIMENSION: MILLIMETERS
3. DIMENSION *b* DOES NOT INCLUDE DAMBAR PROTRUSION. ALLOWABLE PROTRUSION SHALL BE 0.10 mm IN EXCESS OF MAXIMUM MATERIAL CONDITION.
4. DIMENSIONS *D* AND *E* DO NOT INCLUDE MOLD FLASH, PROTRUSION OR GATE BURRS. MOLD FLASH, PROTRUSIONS, OR GATE BURRS SHALL NOT EXCEED 0.15 mm PER SIDE. DIMENSION *E* DOES NOT INCLUDE INTERLEAD FLASH OR PROTRUSION. INTERLEAD FLASH OR PROTRUSION SHALL NOT EXCEED 0.25 mm PER SIDE. DIMENSIONS *D* AND *E* ARE DETERMINED AT DATUM *F*.
5. DATUMS *A* AND *B* ARE TO BE DETERMINED AT DATUM *F*.
6. *A1* IS DEFINED AS THE VERTICAL DISTANCE FROM THE SEATING PLANE TO THE LOWEST POINT ON THE PACKAGE BODY.

$\phi 0.08$ (0.003) M C B S A S

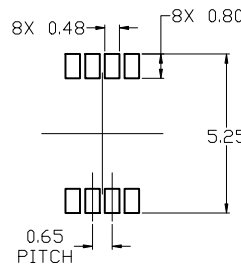

RECOMMENDED MOUNTING FOOTPRINT

DIM	MILLIMETERS		
	MIN.	NOM.	MAX.
A	---	---	1.10
A1	0.05	0.08	0.15
<i>b</i>	0.25	0.33	0.40
<i>c</i>	0.13	0.18	0.23
<i>D</i>	2.90	3.00	3.10
<i>E</i>	2.90	3.00	3.10
<i>e</i>	0.65 BSC		
<i>H_E</i>	4.75	4.90	5.05
<i>L</i>	0.40	0.55	0.70

For additional information on our Pb-Free strategy and soldering details, please download the ON Semiconductor Soldering and Mounting Techniques Reference Manual, SOLDERM/D.

GENERIC MARKING DIAGRAM*



- XXXX = Specific Device Code
- A = Assembly Location
- Y = Year
- W = Work Week
- = Pb-Free Package

(Note: Microdot may be in either location)

*This information is generic. Please refer to device data sheet for actual part marking. Pb-Free indicator, "G" or microdot "▪", may or may not be present. Some products may not follow the Generic Marking.

STYLE 1:

1. SOURCE
2. SOURCE
3. SOURCE
4. GATE
5. DRAIN
6. DRAIN
7. DRAIN
8. DRAIN

STYLE 2:

1. SOURCE 1
2. GATE 1
3. SOURCE 2
4. GATE 2
5. DRAIN 2
6. DRAIN 2
7. DRAIN 1
8. DRAIN 1

STYLE 3:

1. N-SOURCE
2. N-GATE
3. P-SOURCE
4. P-GATE
5. P-DRAIN
6. P-DRAIN
7. N-DRAIN
8. N-DRAIN

DOCUMENT NUMBER:	98ASB14087C	Electronic versions are uncontrolled except when accessed directly from the Document Repository. Printed versions are uncontrolled except when stamped "CONTROLLED COPY" in red.
DESCRIPTION:	MICRO8	PAGE 1 OF 1

ON Semiconductor and ON are trademarks of Semiconductor Components Industries, LLC dba ON Semiconductor or its subsidiaries in the United States and/or other countries. ON Semiconductor reserves the right to make changes without further notice to any products herein. ON Semiconductor makes no warranty, representation or guarantee regarding the suitability of its products for any particular purpose, nor does ON Semiconductor assume any liability arising out of the application or use of any product or circuit, and specifically disclaims any and all liability, including without limitation special, consequential or incidental damages. ON Semiconductor does not convey any license under its patent rights nor the rights of others.

ON Semiconductor and  are trademarks of Semiconductor Components Industries, LLC dba ON Semiconductor or its subsidiaries in the United States and/or other countries. ON Semiconductor owns the rights to a number of patents, trademarks, copyrights, trade secrets, and other intellectual property. A listing of ON Semiconductor's product/patent coverage may be accessed at www.onsemi.com/site/pdf/Patent-Marking.pdf. ON Semiconductor reserves the right to make changes without further notice to any products herein. ON Semiconductor makes no warranty, representation or guarantee regarding the suitability of its products for any particular purpose, nor does ON Semiconductor assume any liability arising out of the application or use of any product or circuit, and specifically disclaims any and all liability, including without limitation special, consequential or incidental damages. Buyer is responsible for its products and applications using ON Semiconductor products, including compliance with all laws, regulations and safety requirements or standards, regardless of any support or applications information provided by ON Semiconductor. "Typical" parameters which may be provided in ON Semiconductor data sheets and/or specifications can and do vary in different applications and actual performance may vary over time. All operating parameters, including "Typicals" must be validated for each customer application by customer's technical experts. ON Semiconductor does not convey any license under its patent rights nor the rights of others. ON Semiconductor products are not designed, intended, or authorized for use as a critical component in life support systems or any FDA Class 3 medical devices or medical devices with a same or similar classification in a foreign jurisdiction or any devices intended for implantation in the human body. Should Buyer purchase or use ON Semiconductor products for any such unintended or unauthorized application, Buyer shall indemnify and hold ON Semiconductor and its officers, employees, subsidiaries, affiliates, and distributors harmless against all claims, costs, damages, and expenses, and reasonable attorney fees arising out of, directly or indirectly, any claim of personal injury or death associated with such unintended or unauthorized use, even if such claim alleges that ON Semiconductor was negligent regarding the design or manufacture of the part. ON Semiconductor is an Equal Opportunity/Affirmative Action Employer. This literature is subject to all applicable copyright laws and is not for resale in any manner.

PUBLICATION ORDERING INFORMATION

LITERATURE FULFILLMENT:

Email Requests to: orderlit@onsemi.com

ON Semiconductor Website: www.onsemi.com

TECHNICAL SUPPORT

North American Technical Support:
Voice Mail: 1 800-282-9855 Toll Free USA/Canada
Phone: 011 421 33 790 2910

Europe, Middle East and Africa Technical Support:

Phone: 00421 33 790 2910

For additional information, please contact your local Sales Representative