

ON Semiconductor

Is Now

onsemi™

To learn more about onsemi™, please visit our website at
www.onsemi.com

onsemi and **onsemi** and other names, marks, and brands are registered and/or common law trademarks of Semiconductor Components Industries, LLC dba "**onsemi**" or its affiliates and/or subsidiaries in the United States and/or other countries. **onsemi** owns the rights to a number of patents, trademarks, copyrights, trade secrets, and other intellectual property. A listing of **onsemi** product/patent coverage may be accessed at www.onsemi.com/site/pdf/Patent-Marking.pdf. **onsemi** reserves the right to make changes at any time to any products or information herein, without notice. The information herein is provided "as-is" and **onsemi** makes no warranty, representation or guarantee regarding the accuracy of the information, product features, availability, functionality, or suitability of its products for any particular purpose, nor does **onsemi** assume any liability arising out of the application or use of any product or circuit, and specifically disclaims any and all liability, including without limitation special, consequential or incidental damages. Buyer is responsible for its products and applications using **onsemi** products, including compliance with all laws, regulations and safety requirements or standards, regardless of any support or applications information provided by **onsemi**. "Typical" parameters which may be provided in **onsemi** data sheets and/or specifications can and do vary in different applications and actual performance may vary over time. All operating parameters, including "Typicals" must be validated for each customer application by customer's technical experts. **onsemi** does not convey any license under any of its intellectual property rights nor the rights of others. **onsemi** products are not designed, intended, or authorized for use as a critical component in life support systems or any FDA Class 3 medical devices or medical devices with a same or similar classification in a foreign jurisdiction or any devices intended for implantation in the human body. Should Buyer purchase or use **onsemi** products for any such unintended or unauthorized application, Buyer shall indemnify and hold **onsemi** and its officers, employees, subsidiaries, affiliates, and distributors harmless against all claims, costs, damages, and expenses, and reasonable attorney fees arising out of, directly or indirectly, any claim of personal injury or death associated with such unintended or unauthorized use, even if such claim alleges that **onsemi** was negligent regarding the design or manufacture of the part. **onsemi** is an Equal Opportunity/Affirmative Action Employer. This literature is subject to all applicable copyright laws and is not for resale in any manner. Other names and brands may be claimed as the property of others.

AND9692/D

DAB Band-III Amplifier Using the NSVF4017SG4



ON Semiconductor®

www.onsemi.com

APPLICATION NOTE

Overview

This application note explains about ON Semiconductor NSVF4017SG4 which is used as a Low Noise Amplifier (LNA) for DAB (Digital Audio Broadcast).

The NSVF4017SG4 is a silicon bipolar transistor best suited for high-frequency applications which is assembled in the 4-pin surface mount package.

For information about the performance, please refer to the datasheet of this product.

Since the evaluation board is adjusted to achieve optimal performance in band-III (170 MHz to 250 MHz), the product can provide 23 dB gain and 1.06 dB noise figure.

A standard material FR4 is used for the printed circuit board (PCB).

Please note that the losses of the PCB and the SMA connector are not excluded from the noise figure.

Table 1. SUMMARY OF DATA

Ta = 25°C, Input Power = -40 dBm

| Parameter | Symbol | Condition | Result | | | Unit |
|-----------------------------------|--------|---|--------|------|------|------|
| DC Voltage | Vcc | | 2.6 | 2.8 | 3.0 | V |
| DC Current | Icc | | 8.5 | 9.4 | 10.3 | mA |
| Gain | Gp1 | f = 170 MHz | 22.8 | 23.2 | 23.6 | dB |
| | Gp2 | f = 210 MHz | 22.6 | 23.0 | 23.3 | dB |
| | Gp3 | f = 250 MHz | 22.0 | 22.4 | 22.7 | dB |
| Noise Figure | NF1 | f = 170 MHz | - | 0.93 | - | dB |
| | NF2 | f = 210 MHz | - | 1.06 | - | dB |
| | NF3 | f = 250 MHz | - | 1.12 | - | dB |
| Input Return Loss | RLin1 | f = 170 MHz | 10.9 | 11.4 | 11.6 | dB |
| | RLin2 | f = 210 MHz | 11.4 | 11.7 | 11.7 | dB |
| | RLin3 | f = 250 MHz | 11.0 | 11.2 | 11.1 | dB |
| Output Return Loss | RLout1 | f = 170 MHz | 13.3 | 14.6 | 15.9 | dB |
| | RLout2 | f = 210 MHz | 13.9 | 15.3 | 16.7 | dB |
| | RLout3 | f = 250 MHz | 14.0 | 14.9 | 15.8 | dB |
| Isolation | ISL1 | f = 170 MHz | 26.0 | 26.4 | 26.7 | dB |
| | ISL2 | f = 210 MHz | 26.0 | 26.4 | 26.7 | dB |
| | ISL3 | f = 250 MHz | 26.2 | 26.6 | 27.0 | dB |
| Gain 1 dB Compression Input Power | Pin1dB | f = 210 MHz | - | -20 | - | dBm |
| Input 3rd Order Intercept Point | IIP3 | f1 = 210 MHz f2 = 211 MHz Pin = -30 dBm | - | -7 | - | dBm |

AND9692/D

Circuit Design

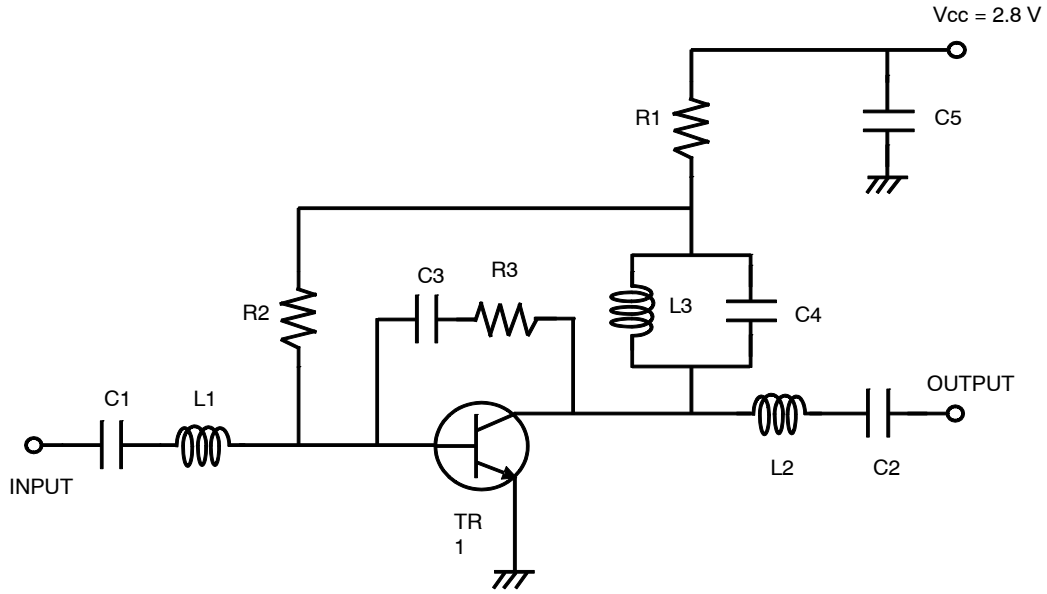

Figure 1. Circuit Design

Evaluation Board

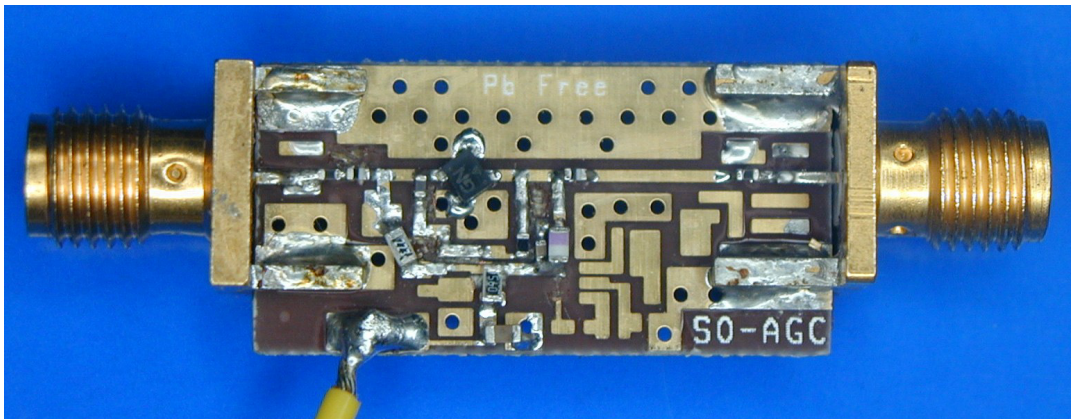

Figure 2. Evaluation Board

Table 2. BILL OF MATERIALS

| Item | Symbol | Value | Manufacturer | Size |
|-----------|----------|----------------|---------------------|----------------|
| Bip-Tr | TR1 | NSVF4017SG4 | ON Semiconductor | SC82FL |
| Capacitor | C1,C2,C3 | 1000 pF | TAIYOYUDEN | 1005 |
| | C4 | 7 pF | TAIYOYUDEN | 1005 |
| | C5 | 0.1 uF | TAIYOYUDEN | 1608 |
| Resistor | R1 | 56 Ω | Various | 1608 |
| | R2 | 22 k Ω | Various | 1608 |
| | R3 | 1.2 k Ω | Various | 1005 |
| Inductor | L1,L2 | 12 nH | TOKO LL1005-FHL12NJ | 1005 |
| | L3 | 120 nH | TOKO LL1608-FS121N | 1608 |
| Material | - | FR4 | - | 25.4 x 12.7 mm |

Power Gain

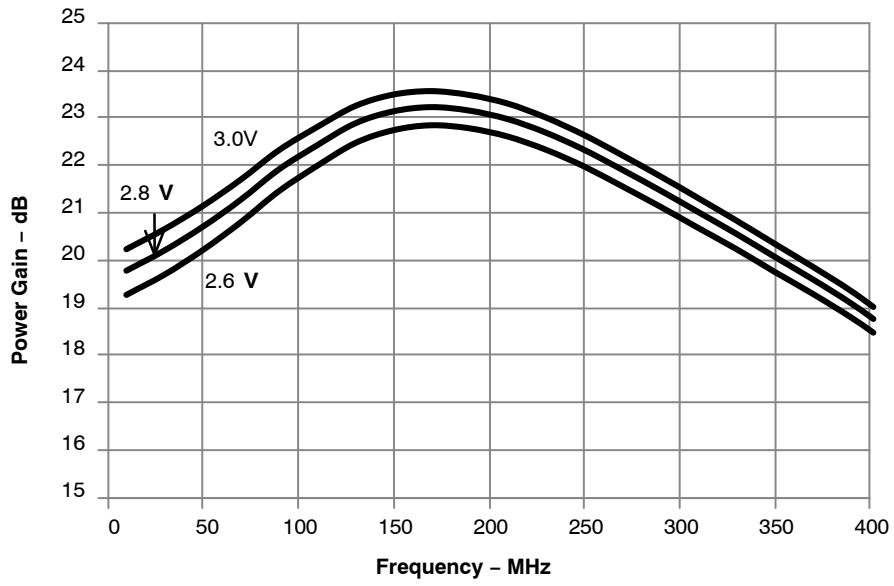

Figure 3. Power Gain

Isolation

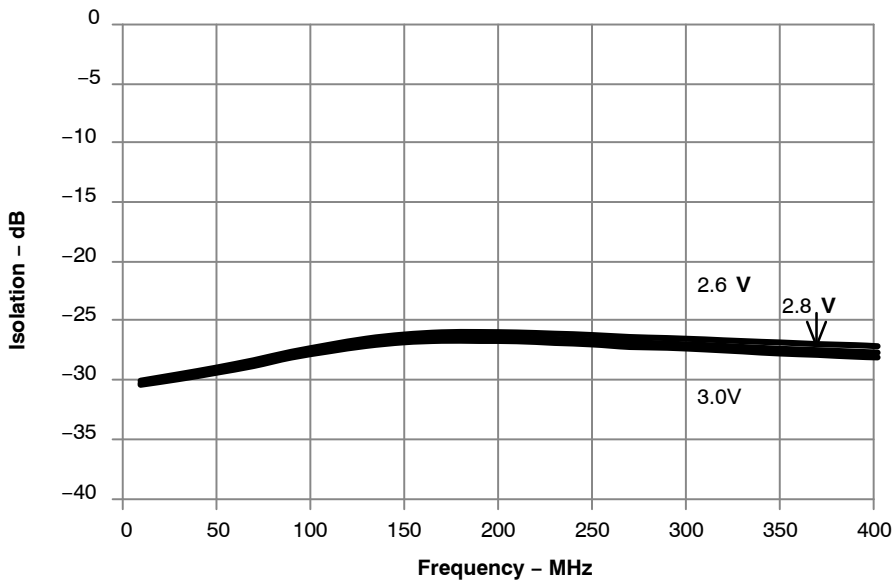

Figure 4. Isolation

AND9692/D

Input Return Loss

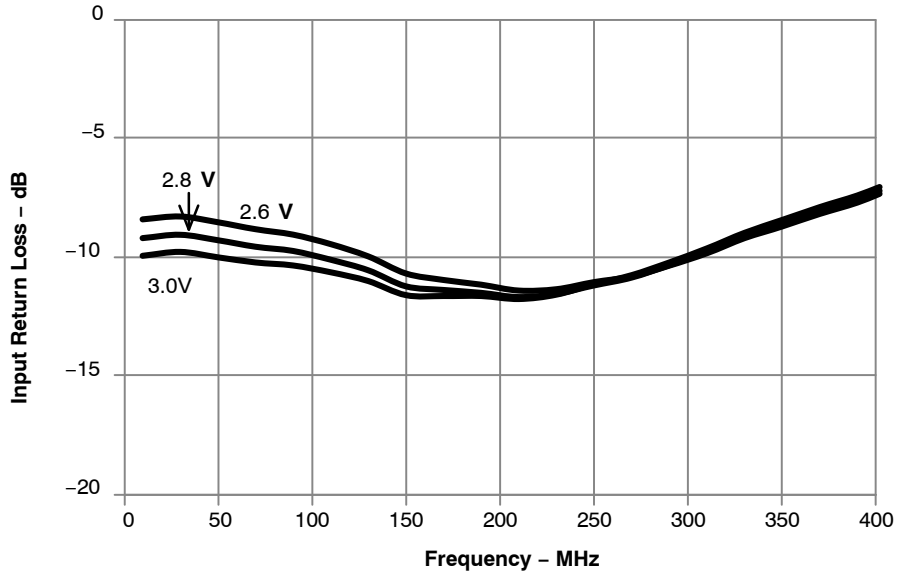

Figure 5. Input Return Loss

Output Return Loss

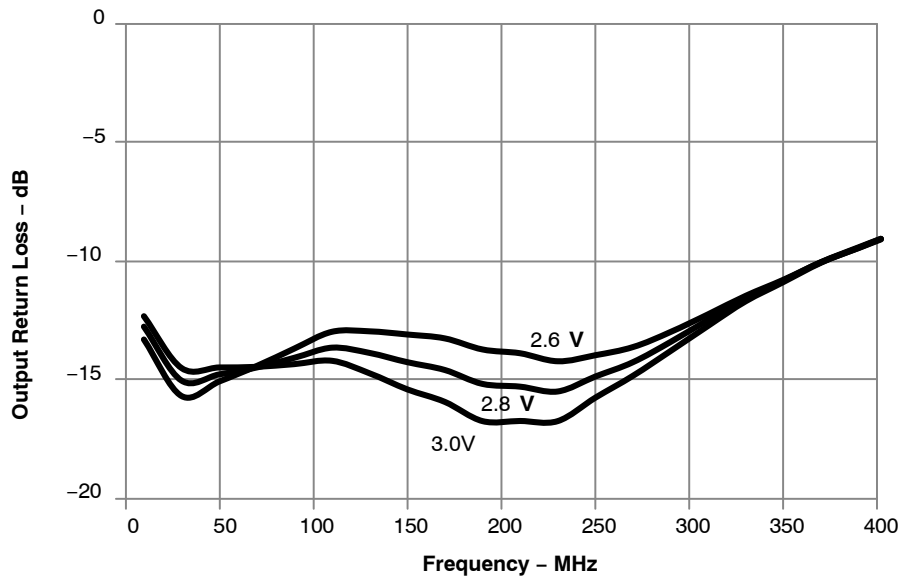

Figure 6. Output Return Loss

AND9692/D

Noise Figure

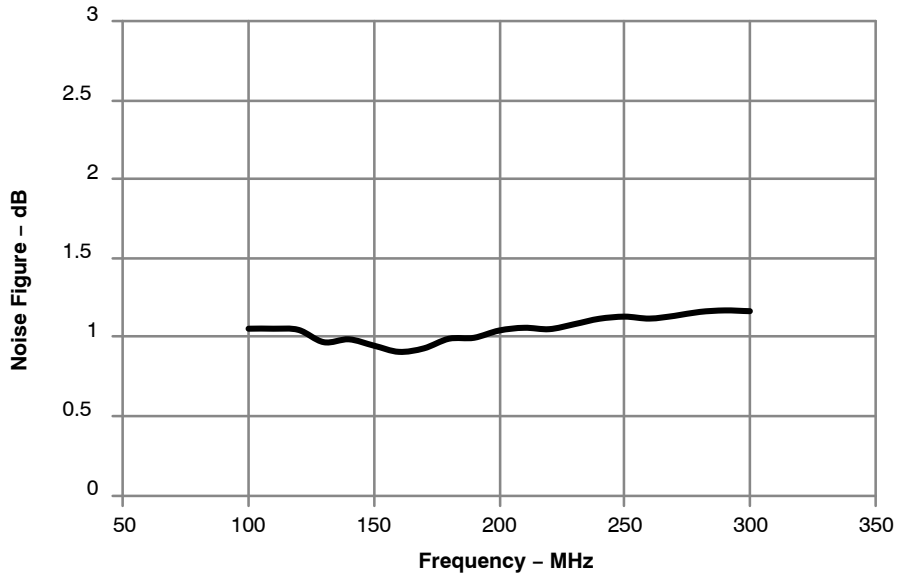

Figure 7. Noise Figure

S11, S21, S12, S22 Wide Span

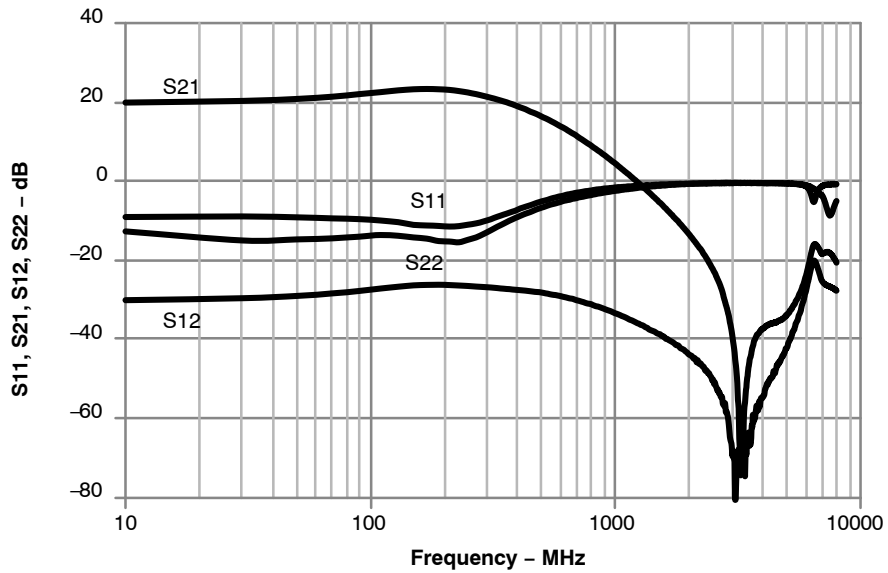

Figure 8. S11, S21, S12, S22 Wide Span

Smith Chart Input Return Loss

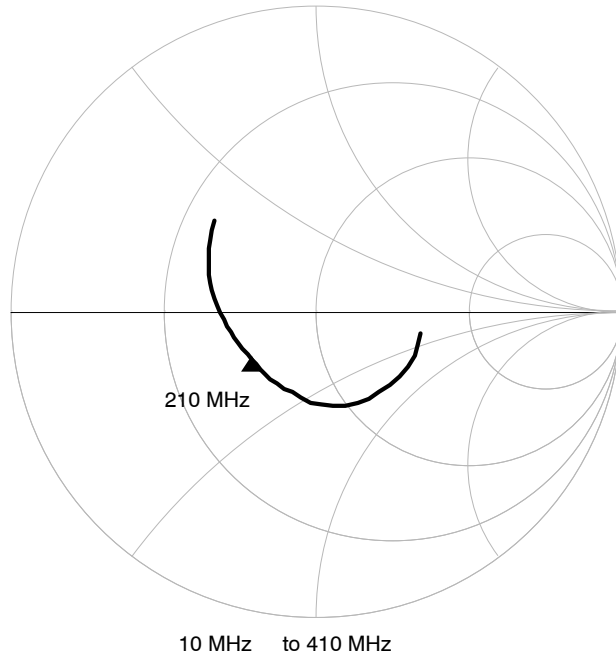

Figure 9. Smith Chart Input Return Loss

Smith Chart Output Return Loss

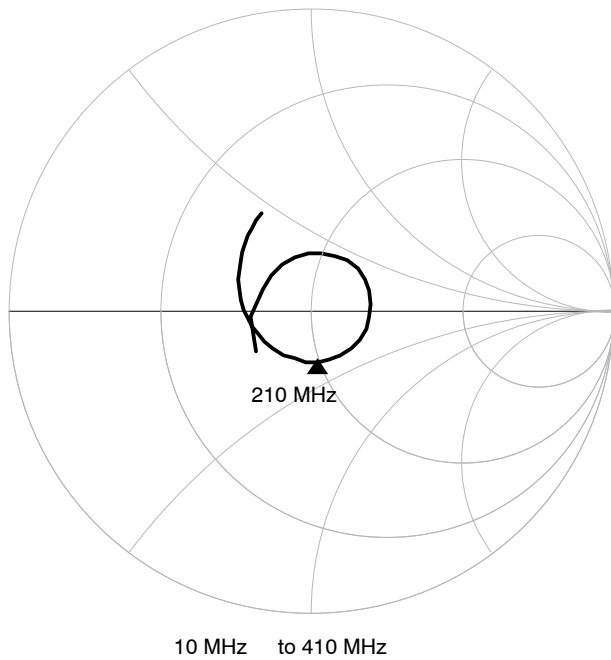

Figure 10. Smith Chart Output Return Loss

AND9692/D

Gain 1 dB Compression Point

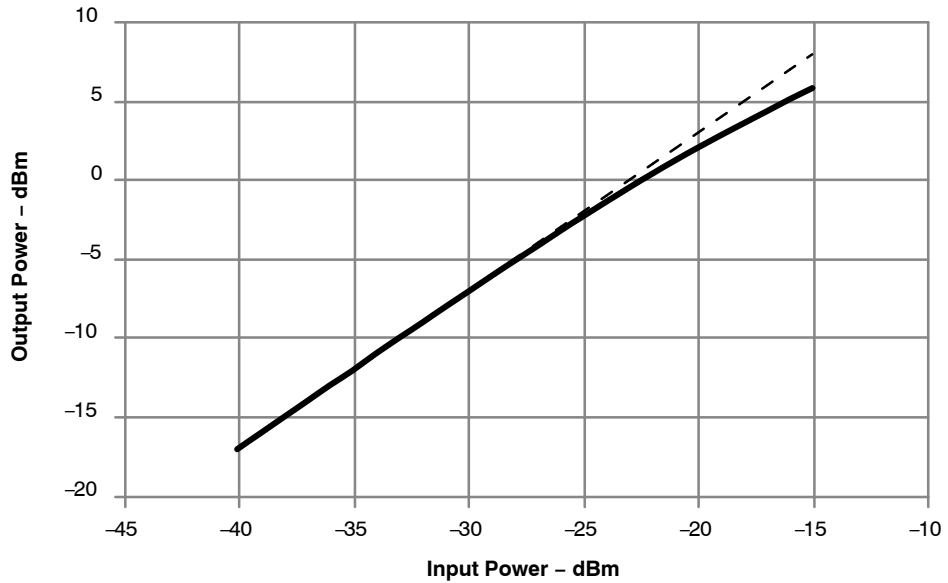

Figure 11. Gain 1 dB Compression Point

Input 3rd Order Intercept Point

f1 = 210 MHz, f2 = 211 MHz, Pin = -30 dBm

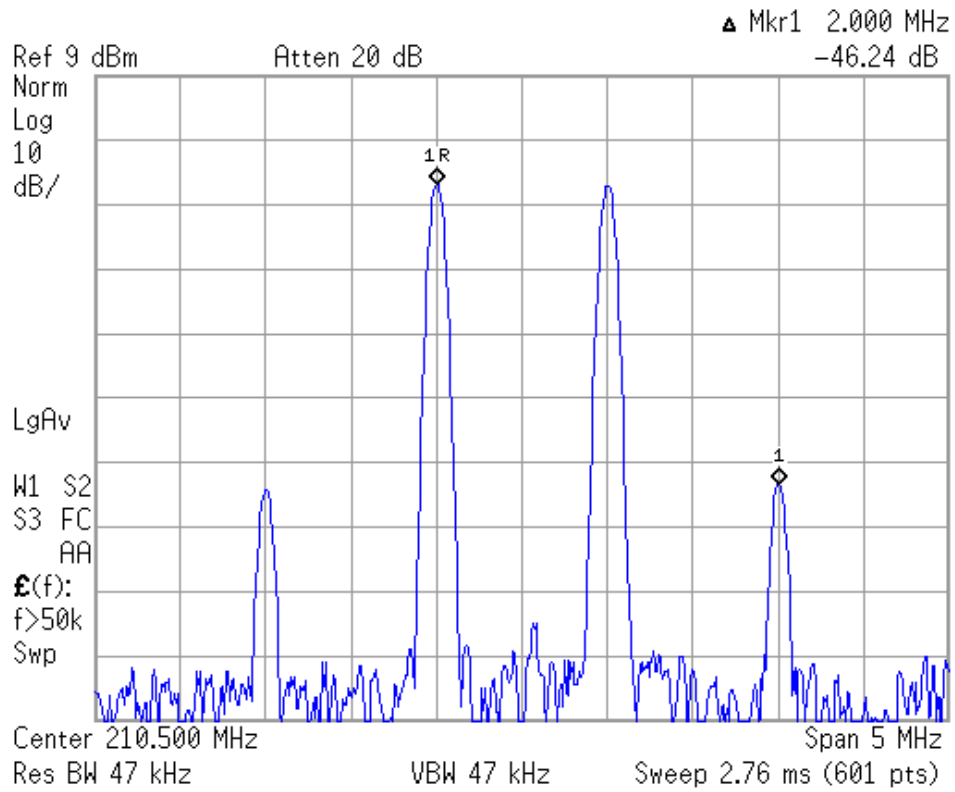



Figure 12. Input 3rd Order Intercept Point

ON Semiconductor and  are trademarks of Semiconductor Components Industries, LLC dba ON Semiconductor or its subsidiaries in the United States and/or other countries. ON Semiconductor owns the rights to a number of patents, trademarks, copyrights, trade secrets, and other intellectual property. A listing of ON Semiconductor's product/patent coverage may be accessed at www.onsemi.com/site/pdf/Patent-Marking.pdf. ON Semiconductor reserves the right to make changes without further notice to any products herein. ON Semiconductor makes no warranty, representation or guarantee regarding the suitability of its products for any particular purpose, nor does ON Semiconductor assume any liability arising out of the application or use of any product or circuit, and specifically disclaims any and all liability, including without limitation special, consequential or incidental damages. Buyer is responsible for its products and applications using ON Semiconductor products, including compliance with all laws, regulations and safety requirements or standards, regardless of any support or applications information provided by ON Semiconductor. "Typical" parameters which may be provided in ON Semiconductor data sheets and/or specifications can and do vary in different applications and actual performance may vary over time. All operating parameters, including "Typicals" must be validated for each customer application by customer's technical experts. ON Semiconductor does not convey any license under its patent rights nor the rights of others. ON Semiconductor products are not designed, intended, or authorized for use as a critical component in life support systems or any FDA Class 3 medical devices or medical devices with a same or similar classification in a foreign jurisdiction or any devices intended for implantation in the human body. Should Buyer purchase or use ON Semiconductor products for any such unintended or unauthorized application, Buyer shall indemnify and hold ON Semiconductor and its officers, employees, subsidiaries, affiliates, and distributors harmless against all claims, costs, damages, and expenses, and reasonable attorney fees arising out of, directly or indirectly, any claim of personal injury or death associated with such unintended or unauthorized use, even if such claim alleges that ON Semiconductor was negligent regarding the design or manufacture of the part. ON Semiconductor is an Equal Opportunity/Affirmative Action Employer. This literature is subject to all applicable copyright laws and is not for resale in any manner.

PUBLICATION ORDERING INFORMATION

LITERATURE FULFILLMENT:

Literature Distribution Center for ON Semiconductor
19521 E. 32nd Pkwy, Aurora, Colorado 80011 USA
Phone: 303-675-2175 or 800-344-3860 Toll Free USA/Canada
Fax: 303-675-2176 or 800-344-3867 Toll Free USA/Canada
Email: orderlit@onsemi.com

N. American Technical Support: 800-282-9855 Toll Free
USA/Canada
Europe, Middle East and Africa Technical Support:
Phone: 421 33 790 2910

ON Semiconductor Website: www.onsemi.com
Order Literature: <http://www.onsemi.com/orderlit>

For additional information, please contact your local Sales Representative