

# FAN4146

## 接地故障断路器

### 说明

FAN4146是一种低功耗控制器，专用于交流插座漏电保护器(ALCI)和两线制漏电保护装置(RCD)。FAN4146可以检测危险的接地条件，并在有害电击发生之前断开线路。

FAN4146内部包含一个二极管整流器、高精度12 V带隙并联稳压器、精密的低 $V_{OS}$ 失调感应放大器、延时噪声滤波器、窗口检测比较器和一个晶闸管驱动器。加入最少数量的外部元件，FAN4146就可以检测和防止火线对地故障。元件数量最少以及小型SUPERSOT™封装，使得FAN4146成为超小型、低成本的应用解决方案。

FAN4146电路包含一个内置整流器和并联稳压器，只需较低的静态电流，允许使用高值、低功率系列电阻。内置温度补偿的并联稳压器、感应放大器以及偏置电路提供高精度对地故障检测。低 $V_{OS}$ 失调感应放大器允许感应线圈直接耦合到放大器的反馈信号端，无需大容量的50/60 Hz交流耦合电容。内置的延时滤波器能够滤除感性负载中的高频噪声尖峰，减少了虚假有害触发。内置的晶闸管驱动器具有温度补偿，该设计可以满足在宽范围内选择外部晶闸管的电流要求。

外部元件数量最少以及6引脚SUPERSOT封装带来了低成本、紧凑设计和布局。FAN4146ESX是一个温度范围增大的器件。

### 特征

- 用于双线ALCI与RCD应用
- 精密感应放大器与带隙基准
- 内置交流整流器
- 直接直流耦合至感应线圈
- 内置噪声滤波器
- 低压晶闸管禁用
- 晶闸管门极驱动器
- 可调敏感度
- 最少外部器件
- 满足UL 943B要求
- 适合120 V or 220 V系统
- 空间节省的SUPERSOT 6引脚封装

### 应用场合

- 个人护理产品
- 两线制电源插头，断路器和要求带有GFI安全设施的电源线
- ALCI和RCCB电路



ON Semiconductor®

[www.onsemi.cn](http://www.onsemi.cn)



1

TSOT23 6-Lead  
CASE 419BL

### MARKING DIAGRAM

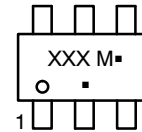

XXX = Specific Device Code

M = Date Code

▪ = Pb-Free Package

### ORDERING INFORMATION

See detailed ordering and shipping information on page 9 of this data sheet.

# FAN4146

## 典型应用

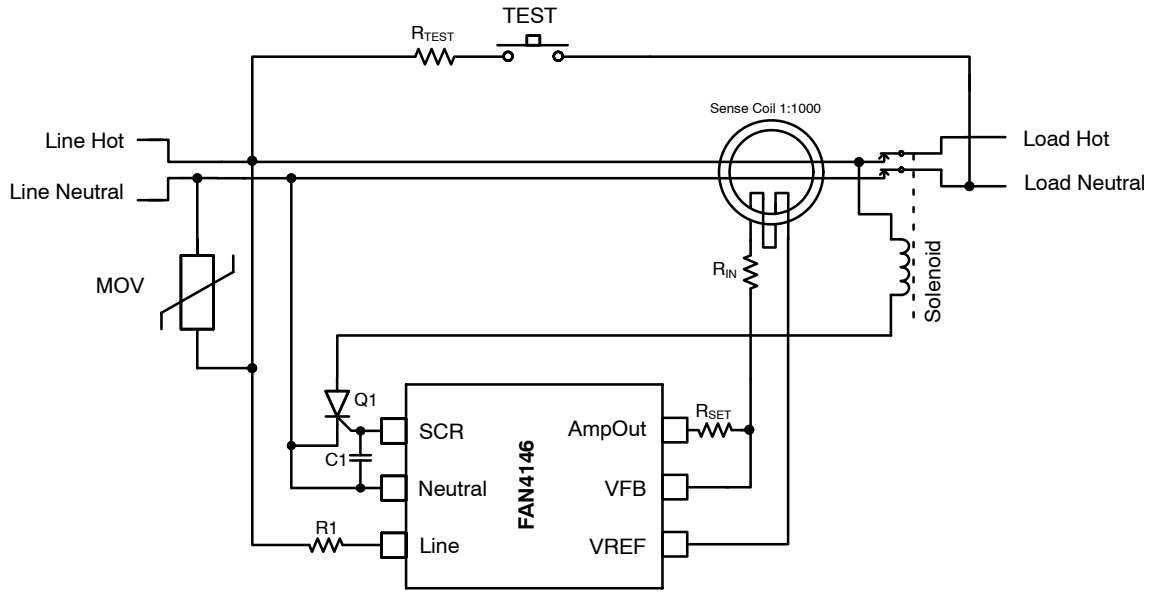

**典型值:**

R1: 91 k $\Omega$  (瓦数取决于V<sub>AC</sub>最大值)

R<sub>TEST</sub>: 15 k $\Omega$

R<sub>SET</sub>: 511 k $\Omega$  (注 1)

R<sub>IN</sub>: 470  $\Omega$

C1: 22 nF

**说明:**

- 取值取决于感应线圈的特性和应用场合(此处按照5 mA触发阈值进行取值)。
- 联系飞兆半导体, 了解最佳应用实践, 抑制有害触发。

图 1. 120/220 V<sub>AC</sub> ALCI 的应用 (注 2)

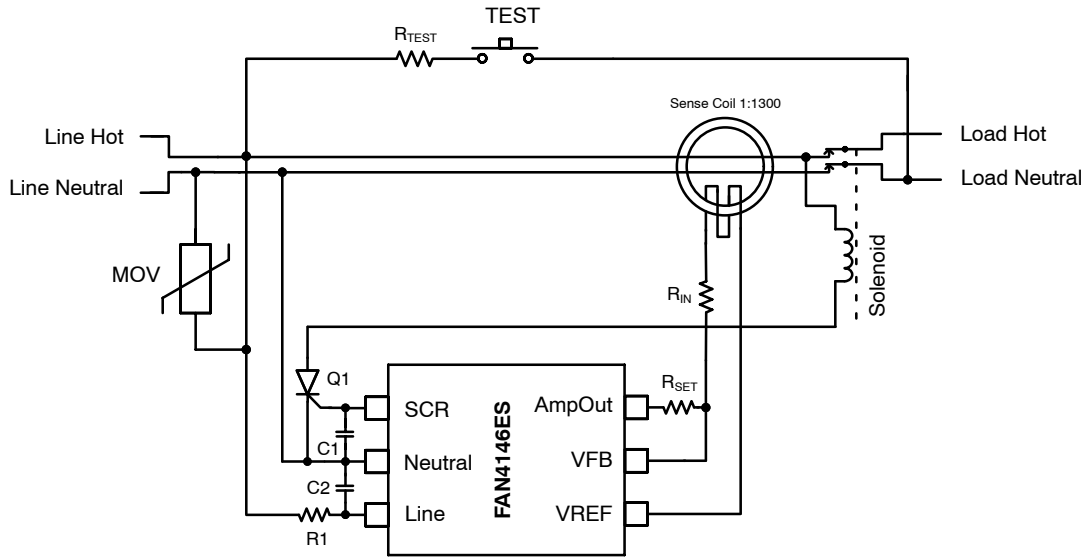

**典型值:**

R1: 174 k $\Omega$  (瓦数取决于V<sub>AC</sub>最大值)

R<sub>TEST</sub>: 15 k $\Omega$

R<sub>SET</sub>: 324 k $\Omega$  (注 3)

R<sub>IN</sub>: 470  $\Omega$

C1: 22 nF

C2: 10 nF

**说明:**

- 取值取决于感应线圈的特性和应用场合(此处按照10 mA触发阈值进行取值)。
- 联系飞兆半导体, 了解最佳应用实践, 抑制有害触发。

图 2. 220 V<sub>AC</sub> RCD 的应用 (注 4)

# FAN4146

## 框图



图 3. 框图

## 引脚布局

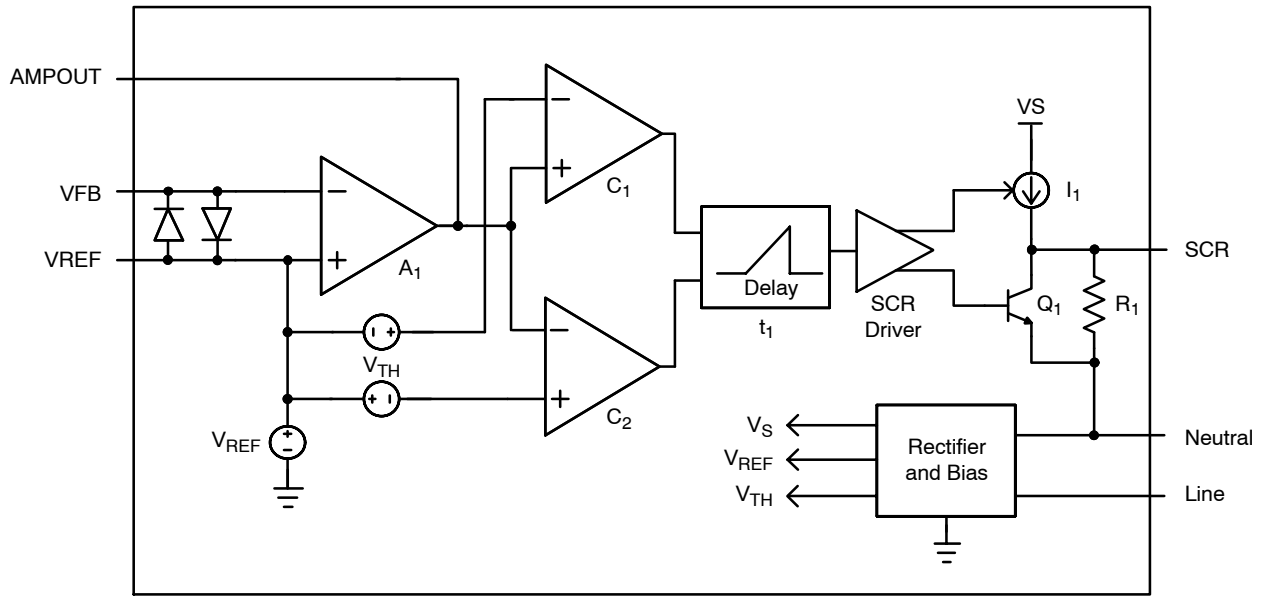

图 4. 引脚布局

## 引脚说明

| 引脚号 | 名称      | 说明                                 |
|-----|---------|------------------------------------|
| 1   | SCR     | 外部晶闸管的门极驱动                         |
| 2   | Neutral | FAN4146电路的电源输入                     |
| 3   | Line    | FAN4146电路的电源输入                     |
| 4   | VREF    | 电流感应放大器的非反相输入                      |
| 5   | VFB     | 电流感应放大器的反相输入                       |
| 6   | AmpOut  | 外部电阻连接到VFB端，可设定 $I_{fault}$ 的灵敏度阈值 |

# FAN4146

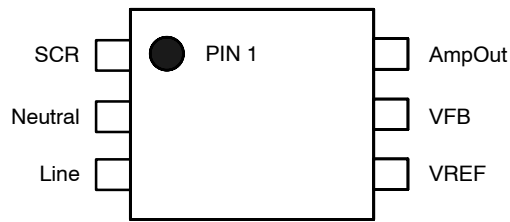
## 绝对最大额定值

| 符号               | 参数     | 条件                  | 最小值  | 最大值  | 单位 |
|------------------|--------|---------------------|------|------|----|
| I <sub>CC</sub>  | 电源电流   | 连续电流, 火线到零线         | -    | 15   | mA |
| V <sub>CC</sub>  | 电源电压   | 连续电压, 火线到零线         | -1.5 | 16.0 | V  |
|                  | 所有其他引脚 | 连续电压到零线             | -0.8 | 15.0 | V  |
| T <sub>STG</sub> | 存储温度范围 |                     | -65  | +150 | °C |
| ESD              | 静电放电能力 | 人体模式, JESD22-A114   | -    | 2500 | V  |
|                  |        | 带电设备模式, JESD22-C101 | -    | 1000 |    |
|                  |        | 机械模式, JESD22-A115   | -    | 200  |    |

Stresses exceeding those listed in the Maximum Ratings table may damage the device. If any of these limits are exceeded, device functionality should not be assumed, damage may occur and reliability may be affected.

(参考译文)

如果电压超过最大额定值表中列出的值范围, 器件可能会损坏。如果超过任何这些限值, 将无法保证器件功能, 可能会导致器件损坏, 影响可靠性。

直流电气特性 (若如其他说明, 所有值都是在 $T_A = 25^\circ\text{C}$ ,  $I_{\text{shunt}} = 1 \text{ mA}$  时得到。)

| 符号                | 参数           | 条件                                                                           | 最小值  | 典型值  | 最大值  | 单位  |
|-------------------|--------------|------------------------------------------------------------------------------|------|------|------|-----|
| V <sub>REG</sub>  | 电源并联稳压器电压    | 电源到零线                                                                        | 12.2 | 12.7 | 13.2 | V   |
|                   |              | 电源到零线, $I_{\text{shunt}} = -2 \text{ mA}$                                    | -0.9 | -0.7 | -    |     |
| I <sub>Q</sub>    | 静态电流         | 电源到零线 = 10 V                                                                 | 350  | 400  | 450  | μA  |
| V <sub>REF</sub>  | 参考电压         | V <sub>REF</sub> 到零线                                                         | 5.8  | 6.0  | 6.2  | V   |
| V <sub>TH</sub>   | 触发阈值         | AmpOut 到 V <sub>REF</sub>                                                    | 3.4  | 3.5  | 3.6  | V   |
| V <sub>OS</sub>   | 放大器偏置        | R <sub>SET</sub> = 511 kΩ, R <sub>IN</sub> = 500 Ω                           | -450 | 0    | 450  | μV  |
| I <sub>OS</sub>   | 放大器输入偏置(注 5) | 设计值                                                                          | -50  | 0    | 50   | nA  |
| G                 | 放大器直流增益(注 5) | 设计值                                                                          | -    | 100  | -    | dB  |
| f <sub>GBW</sub>  | 放大器增益带宽(注 5) | 设计值                                                                          | -    | 1.5  | -    | MHz |
| V <sub>SW+</sub>  | 放大器正电压摆幅     | AmpOut 到 V <sub>REF</sub> , I <sub>FAULT</sub> = 10 μA                       | 4.0  | -    | -    | V   |
| V <sub>SW-</sub>  | 放大器负电压摆幅     | V <sub>REF</sub> 到 AmpOut, I <sub>FAULT</sub> = -10 μA                       | 4.0  | -    | -    | V   |
| I <sub>SINK</sub> | 放大器电流槽       | AmpOut = V <sub>REF</sub> + 3 V, V <sub>FB</sub> = V <sub>REF</sub> + 100 mV | 400  | -    | -    | μA  |
| I <sub>SRL</sub>  | 放大器电流源       | AmpOut = V <sub>REF</sub> - 3 V, V <sub>FB</sub> = V <sub>REF</sub> - 100 mV | 400  | -    | -    | μA  |
| t <sub>d</sub>    | 延时滤波器        | 从C <sub>1</sub> 触发到晶闸管的时延从低到高                                                | 0.75 | 1.00 | 1.25 | ms  |
| R <sub>OUT</sub>  | SCR输出电阻      | SCR-零线 = 250 mV, AmpOut = V <sub>REF</sub>                                   | -    | 0.5  | 1.0  | kΩ  |
| V <sub>OUT</sub>  | SCR输出电压      | SCR-零线, AmpOut = V <sub>REF</sub>                                            | -    | 1    | 10   | mV  |
|                   |              | SCR-零线, AmpOut = V <sub>REF</sub> + 4 V                                      | 2.5  | -    | -    | V   |
| I <sub>OUT</sub>  | SCR输出电流      | SCR-零线 = 1 V AmpOut = V <sub>REF</sub> + 4 V                                 | 350  | 500  | -    | μA  |

Product parametric performance is indicated in the Electrical Characteristics for the listed test conditions, unless otherwise noted. Product performance may not be indicated by the Electrical Characteristics if operated under different conditions.

(参考译文)

除非另有说明, “电气特性”表格中列出的是所列测试条件下的产品性能参数。如果在不同条件下运行, 产品性能可能与“电气特性”表格中所列性能参数不一致。

5. 由设计保证; 未经产品测试。

## 功能说明

(参考图 1和图 3)

FAN4146为双线GFCI控制器，专门用于交流接地故障断路器。在交流电源的正半周，内置整流器整流。内置12 V并联稳压器采用了精密温度补偿带隙基准。精密的基准电路与精密的感应放大器的组合，提供了精确的接地故障容差。使外部元件的参数选择范围更广泛和更低廉。由于所需静态电流较低，可以采用高值的外部串联电阻(R<sub>1</sub>)，大大降低电阻的功耗。12 V并联稳压器为感应放大器(A<sub>1</sub>)的非反相输入端(AC接地参考)提供参考电压V<sub>REF</sub>，并且给延时定时器(t<sub>1</sub>)、比较器(C<sub>1</sub> & C<sub>2</sub>)和晶闸管驱动器提供偏压。

感应变压器的次级绕组直接直流耦合到感应放大器的反相输入端引脚5 (V<sub>FB</sub>)。电阻R<sub>SET</sub>将感应变压器的次级绕组电流在引脚6 (AmpOut)处转换成电压。该电压与内置窗口比较器(C<sub>1</sub>和C<sub>2</sub>)进行比较，如果AmpOut的电压超过阈值电压±V<sub>TH</sub>，窗口比较器就会触发内部延时定时器。如果窗口比较器的输出瞬间为LOW，则定时器t<sub>1</sub>复位。如果在t<sub>1</sub>脉冲结束时，窗口比较器输出一直为HIGH，则晶闸管驱动器启动电流源I<sub>1</sub>，禁止Q<sub>1</sub>。然后电流源I<sub>1</sub>开启外部晶闸管，给电磁阀通电，打开连接负载的接触开关，从而消除有害接地故障。窗口比较器允许检测正的或负的I<sub>FAULT</sub>信号，不依赖于电源电压的相位。当引脚3 (LINE)的电压低于7.5 V时，内部欠压闭锁电路将关闭晶闸管驱动器。杜绝晶闸管阳极电压低于65 V时晶闸管继续给螺线管通电。

感应变压器通常都有一个由复合钢环或者固体铁氧体制成的环形磁芯。一般情况下，变压器次级要求由40#线在该环形磁芯上绕1000匝。变压器初级通常为一匝，交流火线和零线穿过该环形磁芯中央。当接地故障出现时，流入火线与零线的电流出现偏差。通过将初级差动电流除以初级与次级之间的匝比就可得到了变压器的次级电流。

电阻R<sub>SET</sub>的计算

AmpOut的信号必须超过窗口比较器的阈值电压V<sub>TH</sub>，持续时间超过延时定时器时间，计算如下：

$$V_{TH} = I_{FAULT} \times 1.41 \times R_{SET} \times \frac{\cos\left(2\pi \times \frac{t}{2P}\right)}{N} \quad (\text{eq. 1})$$

$$R_{SET} = \frac{V_{TH} \times N}{1.41 \times I_{FAULT} \times \cos\left(\pi \times \frac{t}{P}\right)} \quad (\text{eq. 2})$$

式中：

|                    |                       |
|--------------------|-----------------------|
| V <sub>TH</sub>    | = 3.5 V               |
| I <sub>FAULT</sub> | = 5 mA (UL943B)       |
| t                  | = 1 ms (定时器延时)        |
| P                  | = 交流电源周期(1/60 Hz)     |
| N                  | = 次级与初级匝比(1000:1)     |
| R <sub>SET</sub>   | = 505 kΩ (511 kΩ标准1%) |

在实际中，由于变压器不理想，需要调节R<sub>SET</sub>，范围高达30%，才能获得所需的I<sub>fault</sub>触发阈值。

V<sub>OS</sub>触发阈值误差的计算

由于感应线圈直接连接到感应放大器的反馈端，V<sub>OS</sub>偏置会引入一个I<sub>fault</sub>阈值误差，计算如下：

$$\%Error = 100 \times \frac{V_{OS} \times R_{SET}}{R_{IN} + R_{LDC} + R_{LAC}} \times \frac{1}{V_{TH}} \quad (\text{eq. 3})$$

式中：

|                  |                           |
|------------------|---------------------------|
| V <sub>OS</sub>  | = ±450 μV (最差情况)          |
|                  | = ±150 μV (典型值)           |
| R <sub>SET</sub> | = 511 kΩ                  |
| R <sub>IN</sub>  | = 470 Ω (典型值)             |
| R <sub>LDC</sub> | = 75 Ω (感性线圈次级直流电阻)       |
| R <sub>LAC</sub> | = 1.5 kΩ (AC(jωL) 感应线圈阻抗) |
|                  | L = 4 H, f = 60 Hz)       |
| V <sub>TH</sub>  | = 3.5 V                   |
| %Error           | = ±3.2% (最差情况)            |
|                  | = ±1.1% (典型值)             |

# FAN4146

## 典型性能特征

(若如其他说明, 所有值都是在 $T_A = 25^\circ\text{C}$ , 晶闸管断开(根据图 1)情况下得到。)



图 5. 无接地故障时典型波形



图 6. 4 mA 接地故障时典型波形

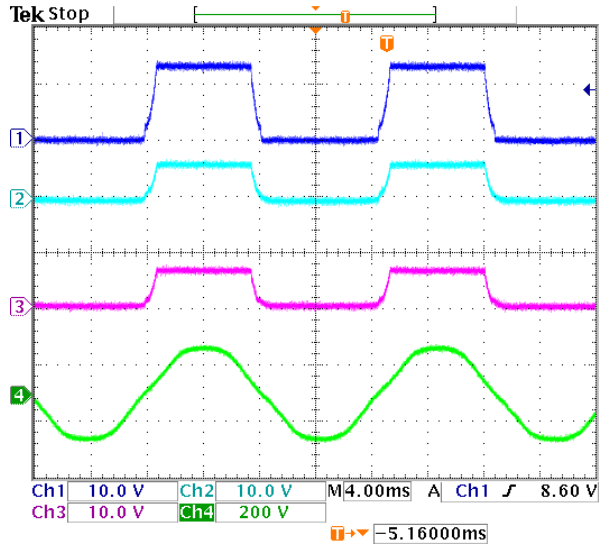

图 7. 5 mA 接地故障时典型波形

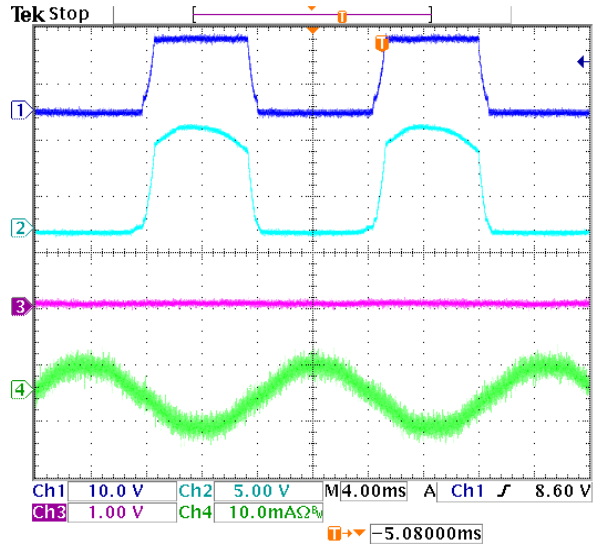

图 8. 5 mA 接地故障时典型波形(线路极性反转)

# FAN4146

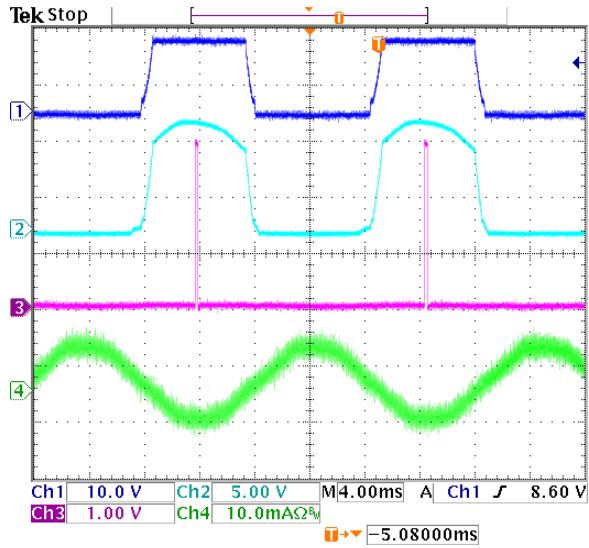
## 典型性能特征 (接上页)

(若如其他说明, 所有值都是在 $T_A = 25^\circ\text{C}$ , 晶闸管断开(根据图 1)情况下得到。)

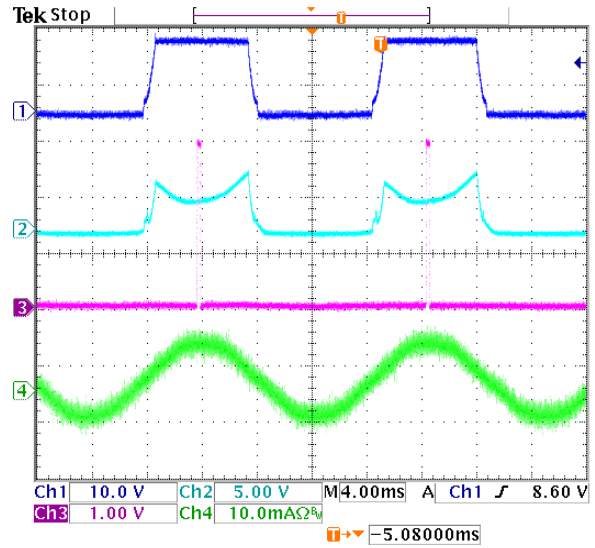
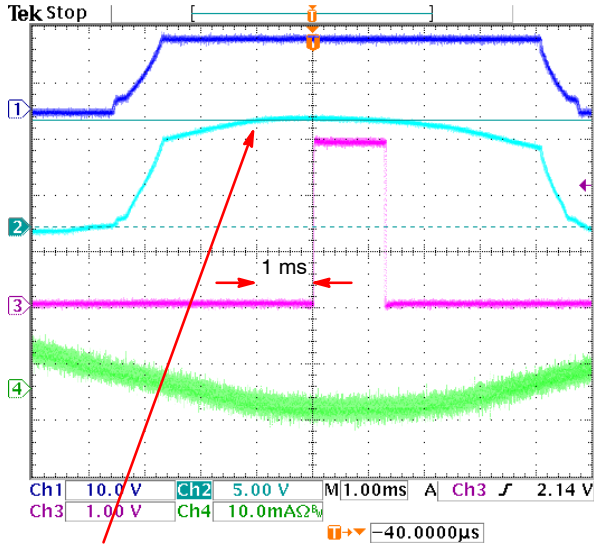

AmpOut信号达到9.5 V后1 ms, 触发晶闸管。

通道1:  $V_{Line}$  (引脚 3), 10 V/Div  
通道2: AmpOut (引脚 6), 5 V/Div  
通道3: SCR (引脚 1), 1 V/Div  
通道4:  $I_{FAULT}$ , 10 mA/Div

图 9. AmpOut阈值, 内部1 ms延时

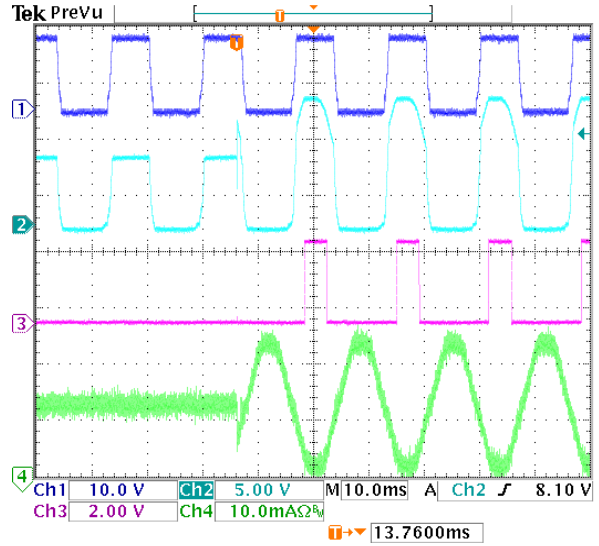

通道1:  $V_{Line}$  (引脚 3), 10 V/Div  
通道2: AmpOut (引脚 6), 5 V/Div  
通道3: SCR (引脚 1), 2 V/Div  
通道4:  $I_{FAULT}$ , 10 mA/Div

图 10. 15 kΩ 接地故障

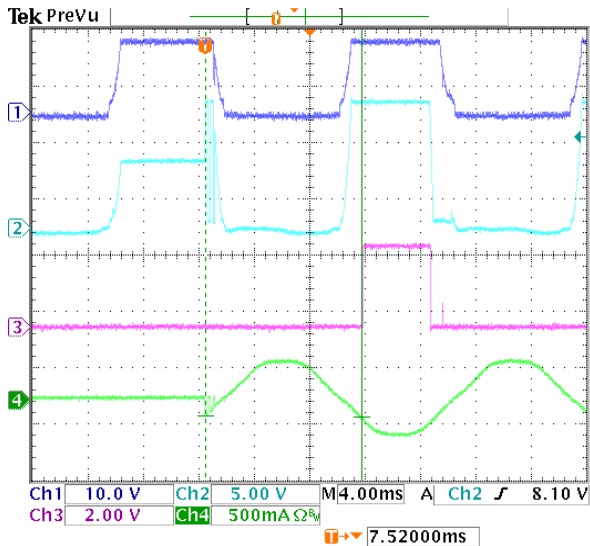

通道1:  $V_{Line}$  (引脚 3), 10 V/Div  
通道2: AmpOut (引脚 6), 5 V/Div  
通道3: SCR (引脚 1), 2 V/Div  
通道4:  $I_{FAULT}$ , 500 mA/Div

图 11. 500 Ω 接地故障 (说明 6, 7)

说明:

6. 最大触发时间~12 ms。
7. 交流正半周结束时发生故障。

# FAN4146

## 典型温度特性(FAN4146E)



图 12. 阈值电压( $V_{TH}$ )相对温度的曲线



图 13. 参考电压( $V_{REF}$ )相对温度的曲线

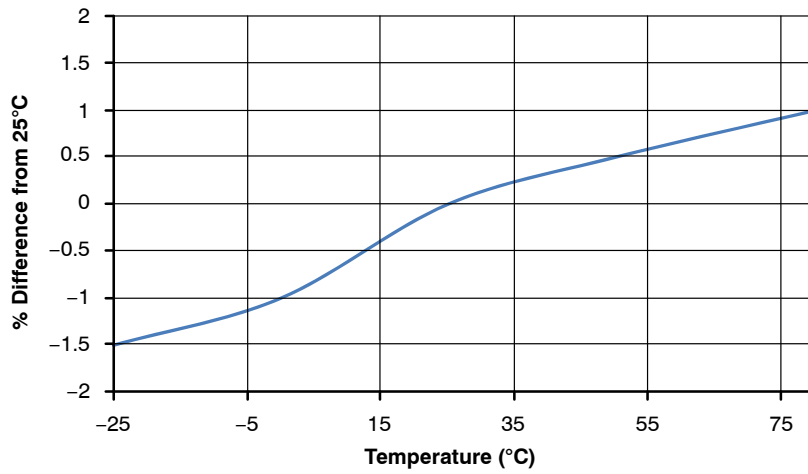

图 14. SCR输出电流( $I_{OUT}$ )相对温度的曲线

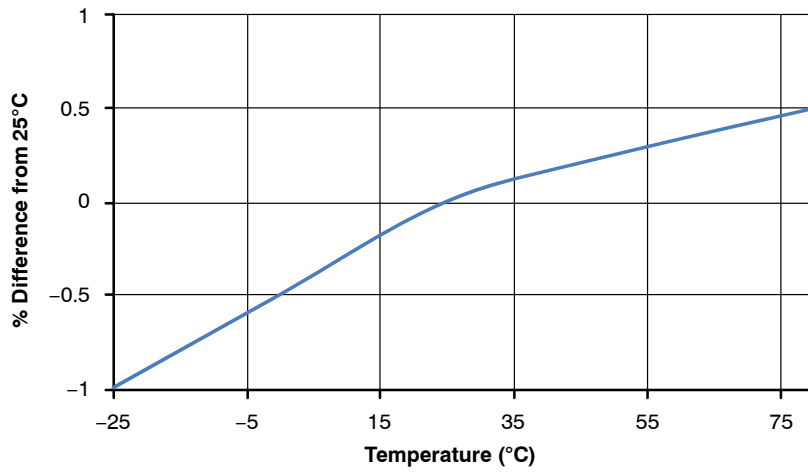

## FAN4146

### 订购信息

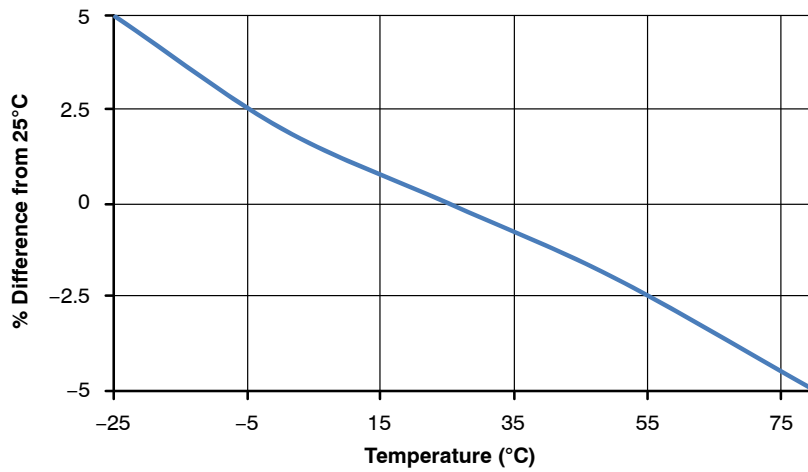
| 器件型号       | 工作温度范围        | 封装                         | 包装 <sup>†</sup>     |
|------------|---------------|----------------------------|---------------------|
| FAN4146SX  | 0°C 至 +70°C   | TSOT23 6-Lead<br>(Pb-Free) | 3,000 / Tape & Reel |
| FAN4146ESX | -35°C 至 +85°C | TSOT23 6-Lead<br>(Pb-Free) | 3,000 / Tape & Reel |

<sup>†</sup>For information on tape and reel specifications, including part orientation and tape sizes, please refer to our Tape and Reel Packaging Specifications Brochure, BRD8011/D.

SUPERSOT is a trademark of Semiconductor Components Industries, LLC (SCILLC) or its subsidiaries in the United States and/or other countries.

# MECHANICAL CASE OUTLINE

## PACKAGE DIMENSIONS

ON Semiconductor®



1  
SCALE 2:1

### TSOT23 6-Lead CASE 419BL ISSUE A

DATE 31 AUG 2020

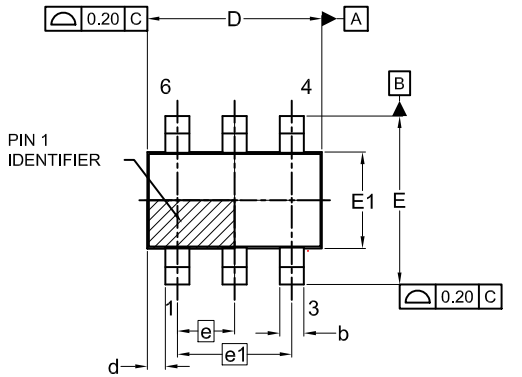

TOP VIEW

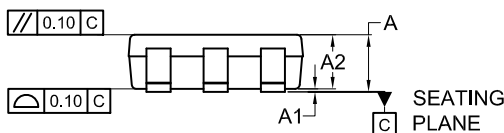

FRONT VIEW

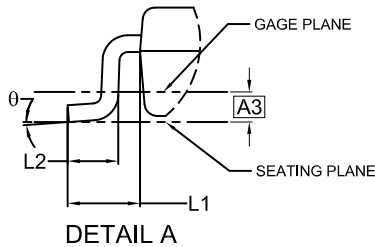

DETAIL A

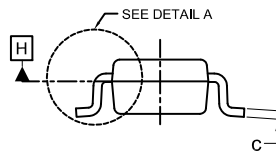

SIDE VIEW

SYMM  
⌀

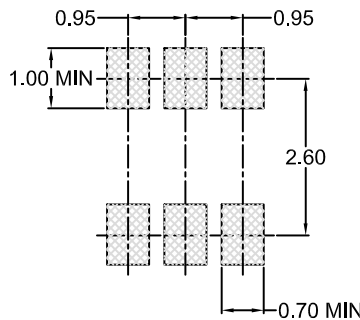

LAND PATTERN  
RECOMMENDATION

\*FOR ADDITIONAL INFORMATION ON OUR  
Pb-FREE STRATEGY AND SOLDERING DETAILS,  
PLEASE DOWNLOAD THE ON SEMICONDUCTOR  
SOLDERING AND MOUNTING TECHNIQUES  
REFERENCE MANUAL, SOLDERRM/D.

NOTES:

1. DIMENSIONING AND TOLERANCING PER ASME Y14.5M, 2009.
2. CONTROLLING DIMENSION: MILLIMETERS
3. DIMENSIONS D AND E1 DO NOT INCLUDE MOLD FLASH, PROTRUSIONS, OR GATE BURRS. MOLD FLASH, PROTRUSIONS OR GATE BURRS SHALL NOT EXCEED 0.25MM PER END. DIMENSIONS D AND E1 ARE DETERMINED AT DATUM H.
4. SEATING PLANE IS DEFINED BY THE TERMINALS. "A1" IS DEFINED AS THE DISTANCE FROM THE SEATING PLANE TO THE LOWEST POINT ON THE PACKAGE BODY.

| DIM | MILLIMETERS |      |      |
|-----|-------------|------|------|
|     | MIN.        | NOM. | MAX. |
| A   | 0.90        | 1.00 | 1.10 |
| A1  | 0.00        | 0.05 | 0.10 |
| A2  | 0.70        | 0.85 | 1.00 |
| A3  | 0.25 BSC    |      |      |
| b   | 0.25        | 0.38 | 0.50 |
| c   | 0.10        | 0.18 | 0.26 |
| D   | 2.80        | 2.95 | 3.10 |
| d   | 0.30 REF    |      |      |
| E   | 2.50        | 2.75 | 3.00 |
| E1  | 1.30        | 1.50 | 1.70 |
| e   | 0.95 BSC    |      |      |
| e1  | 1.90 BSC    |      |      |
| L1  | 0.60 REF    |      |      |
| L2  | 0.20        | 0.40 | 0.60 |
| ⌀   | 0°          | --   | 10°  |

#### GENERIC MARKING DIAGRAM\*

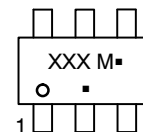

- XXX = Specific Device Code
- M = Date Code
- = Pb-Free Package

(Note: Microdot may be in either location)

\*This information is generic. Please refer to device data sheet for actual part marking. Pb-Free indicator, "G" or microdot "▪", may or may not be present. Some products may not follow the Generic Marking.

|                  |               |                                                                                                                                                                                  |
|------------------|---------------|----------------------------------------------------------------------------------------------------------------------------------------------------------------------------------|
| DOCUMENT NUMBER: | 98AON83292G   | Electronic versions are uncontrolled except when accessed directly from the Document Repository. Printed versions are uncontrolled except when stamped "CONTROLLED COPY" in red. |
| DESCRIPTION:     | TSOT23 6-Lead | PAGE 1 OF 1                                                                                                                                                                      |

ON Semiconductor and are trademarks of Semiconductor Components Industries, LLC dba ON Semiconductor or its subsidiaries in the United States and/or other countries. ON Semiconductor reserves the right to make changes without further notice to any products herein. ON Semiconductor makes no warranty, representation or guarantee regarding the suitability of its products for any particular purpose, nor does ON Semiconductor assume any liability arising out of the application or use of any product or circuit, and specifically disclaims any and all liability, including without limitation special, consequential or incidental damages. ON Semiconductor does not convey any license under its patent rights nor the rights of others.

ON Semiconductor and  are trademarks of Semiconductor Components Industries, LLC dba ON Semiconductor or its subsidiaries in the United States and/or other countries. ON Semiconductor owns the rights to a number of patents, trademarks, copyrights, trade secrets, and other intellectual property. A listing of ON Semiconductor's product/patent coverage may be accessed at [www.onsemi.com/site/pdf/Patent-Marking.pdf](http://www.onsemi.com/site/pdf/Patent-Marking.pdf). ON Semiconductor reserves the right to make changes without further notice to any products herein. ON Semiconductor makes no warranty, representation or guarantee regarding the suitability of its products for any particular purpose, nor does ON Semiconductor assume any liability arising out of the application or use of any product or circuit, and specifically disclaims any and all liability, including without limitation special, consequential or incidental damages. Buyer is responsible for its products and applications using ON Semiconductor products, including compliance with all laws, regulations and safety requirements or standards, regardless of any support or applications information provided by ON Semiconductor. "Typical" parameters which may be provided in ON Semiconductor data sheets and/or specifications can and do vary in different applications and actual performance may vary over time. All operating parameters, including "Typicals" must be validated for each customer application by customer's technical experts. ON Semiconductor does not convey any license under its patent rights nor the rights of others. ON Semiconductor products are not designed, intended, or authorized for use as a critical component in life support systems or any FDA Class 3 medical devices or medical devices with a same or similar classification in a foreign jurisdiction or any devices intended for implantation in the human body. Should Buyer purchase or use ON Semiconductor products for any such unintended or unauthorized application, Buyer shall indemnify and hold ON Semiconductor and its officers, employees, subsidiaries, affiliates, and distributors harmless against all claims, costs, damages, and expenses, and reasonable attorney fees arising out of, directly or indirectly, any claim of personal injury or death associated with such unintended or unauthorized use, even if such claim alleges that ON Semiconductor was negligent regarding the design or manufacture of the part. ON Semiconductor is an Equal Opportunity/Affirmative Action Employer. This literature is subject to all applicable copyright laws and is not for resale in any manner.

## PUBLICATION ORDERING INFORMATION

### LITERATURE FULFILLMENT:

Email Requests to: [orderlit@onsemi.com](mailto:orderlit@onsemi.com)

ON Semiconductor Website: [www.onsemi.com](http://www.onsemi.com)

### TECHNICAL SUPPORT

North American Technical Support:  
Voice Mail: 1 800-282-9855 Toll Free USA/Canada  
Phone: 011 421 33 790 2910

Europe, Middle East and Africa Technical Support:

Phone: 00421 33 790 2910

For additional information, please contact your local Sales Representative