

FOR ENERGY EFFICIENT INNOVATIONS

THINK ON.

www.onsemi.com

CSD: Intelligent Sensing Group

February 2020

Public Information



Global Shutter Enhances Machine Vision : AR0234

Example of high performance global shutter capture

AR0234 2.3MP global shutter

Leading shutter efficiency
Enables Machine Vision outdoors

High QE at NIR light
Reduces active illumination power
Increases range for depth applications

Compact 1/2.6" format

120fps for MV applications

Global Shutter



Rolling Shutter



QE at NIR

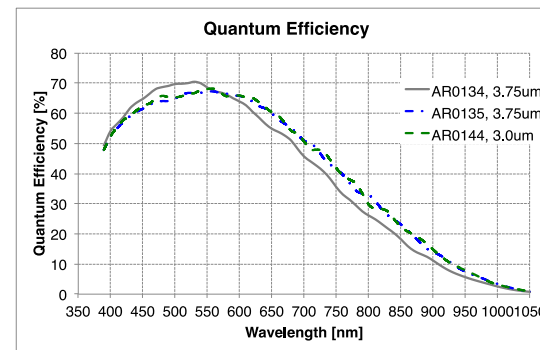

Shutter Efficiency

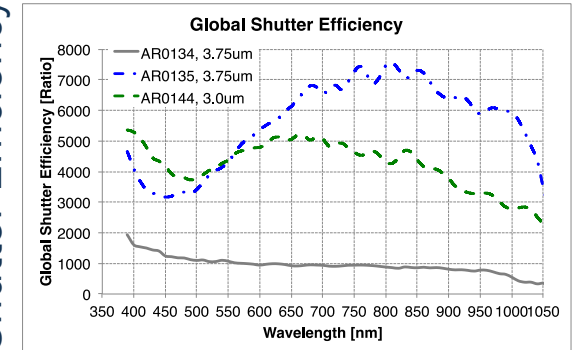

Leading Perf / Watt In An Ultra Compact Package : ARX3A0

Advanced Features and Benefits

- Global Shutter Functions, Rolling Shutter Performance
- Intelligent Motion Sensing
- Enhanced Near Infra Red
- Ultra Low Power
- Small size

Colour version to be released in Q2CY20



Major OEM Interest Funnel is Growing

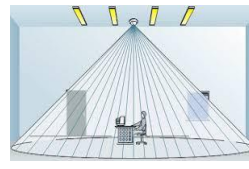
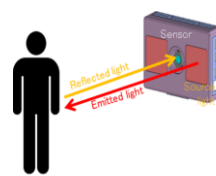
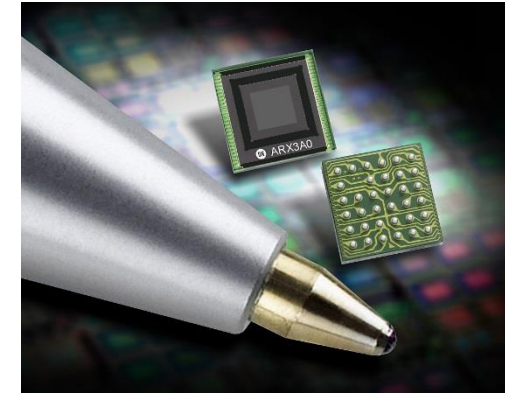

Linear and HDR Mode Comparison : AR0239



1-exposure



2-exposure



3-exposure

Public Information



Scalable Power in Image Sensors : AR0430

- Low Power Design: Smart Design
- Aggressive Clocking Reduction
- Scalable Power
 - Always on operation



AR0430 : 4MP image sensor example

The IAS Hardware Ecosystem

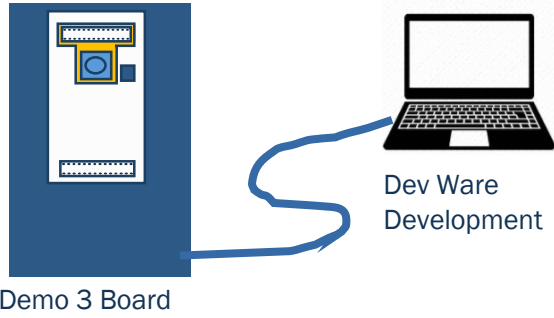

Partner Reference Designs

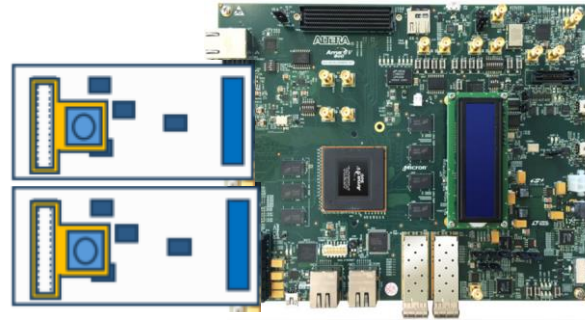

Customer end System

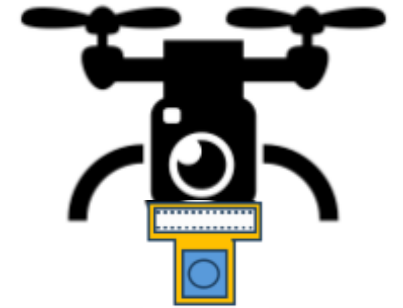

IAS Interface boards

- ON Semi GEVB OPNs
- Power supply (reference design)
- Interface to Demo 3
- Interface to Partner Reference designs

Standard IAS module to Demo 3

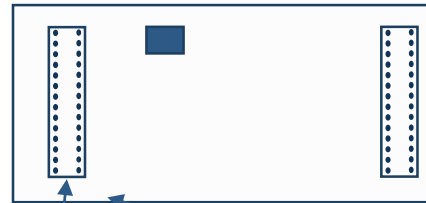

Standard IAS module to Partner 1,2,3

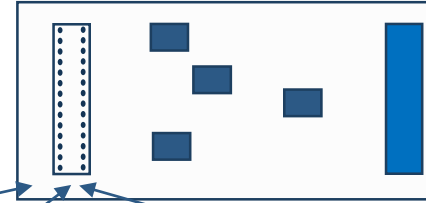

Custom module to Demo 3

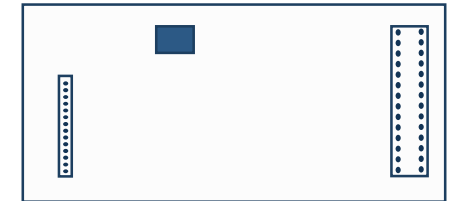

Standardized
IAS
Module
Connector
Pinning

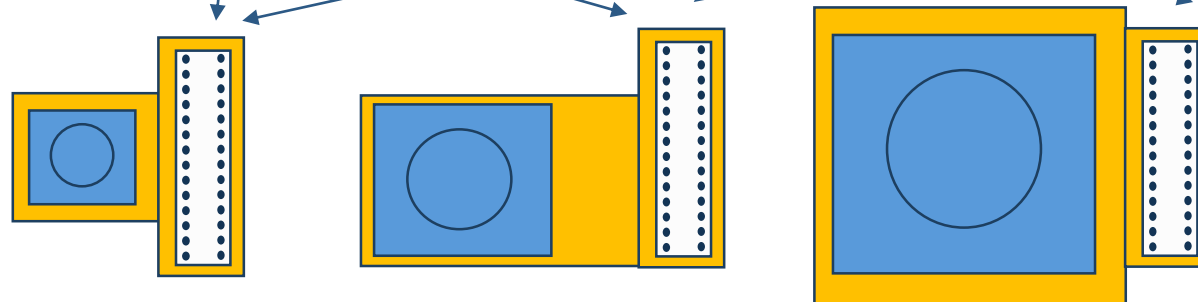

System allows alternate
"Custom" changes



Expanding Support of System Solutions

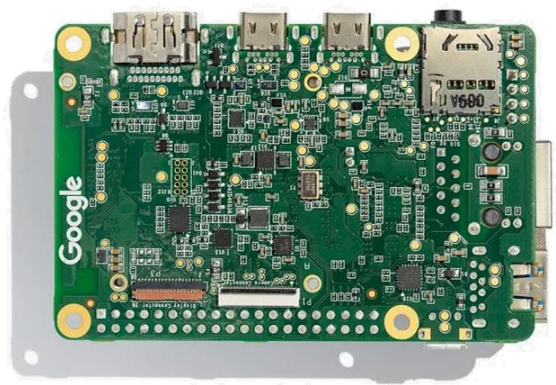

Coral (eTPU)



UltraScale ZU3



Jetson Nano



IMX8

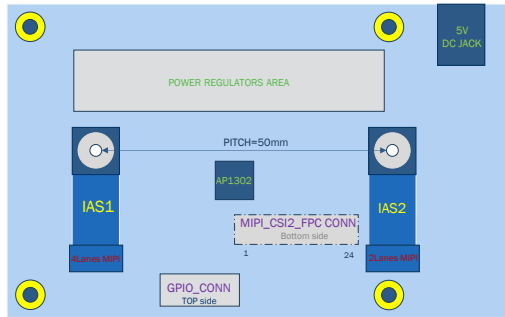

IAS Adaptor Board

